



At the heart of your home

GAS FIRES 2016





At the heart of your home

Welcome to Flavel



BFM Europe
BRITISH FIRE MANUFACTURERS

Today BFM Europe is the fastest growing domestic fire producer in the country with an unequalled reputation for quality and service. Every Flavel branded gas fire is developed and manufactured in Britain at our purpose built, state-of-the-art facility in Stoke-on-Trent.



See page 7 for details about our 7 year guarantee



At Flavel we know how important it is to create a stylish and relaxing living environment. That's why we've developed this collection of affordable gas fires to complement all tastes and lifestyles. I believe our success stems from a combination of innovative design, investment in technology and the highest quality manufacturing standards. As a result all Flavel gas fires carry a 7 year guarantee to reflect my belief in their quality and durability. This brochure has been designed to make the purchase of your new Flavel gas fire as simple as possible. I hope you will find it both informative and inspiring.

bsi. Product Testing & Certification

All our gas fires are independently tested, approved and verified by the British Standards Institution (BSI).

The BSI is an independent organisation. They are not owned by the government, industry or shareholders, which means that they can be totally objective with regards testing and certification. This gives their assessments more authority than those of an organization that has a vested interest in promoting its members.

They have some of the most experienced and knowledgeable staff in the world and are recognised internationally for their technical expertise, quality services and in-depth knowledge of gas, electrical, oil and solid fuel product testing and certification.

The wide-ranging capability of their testing facilities and the broad expertise and knowledge of their testing and certification staff ensures our products are rigorously tested with the utmost integrity.

Contents

Hole in the Wall & Wall Mounted fires



Castelle Slimline Page 9

Castelle Slimline	9
Finesse.....	10
Windsor Contemporary Wall Mounted, Plus & HE.....	11
Curve.....	12
Kamina	13
Expression HE.....	14
Diamond HE.....	15
Rocco HE & Rocco Balanced Flue.....	16
Jazz HE & Jazz Balanced Flue.....	17

An introduction to High Efficiency Gas Fires	4
Guide to icons	6

Slimline Hearth Mounted Fires



Windsor Traditional Page 19

Windsor Contemporary, Plus & HE.....	18
Windsor Traditional, Plus & HE & Windsor Classic.....	19
Melody.....	20
Warwick.....	21
Stirling Plus.....	22
Caress Slimline	23
Decadence HE Slimline	24
Raglan Balanced Flue.....	25
Orchestra Balanced Flue.....	26
Atlanta Balanced Flue	27

Full Depth Hearth Mounted Fires



Linear coal Page 33

Waverley	29
Calypso & Calypso Plus	30
Rhapsody & Rhapsody Plus.....	31
Kenilworth, Kenilworth Plus, HE & Powerflue.....	32
Linear, Linear Plus, HE & Powerflue.....	33
Caress, Caress Plus & Caress HE.....	34
Richmond & Richmond Plus.....	35
Decadence Plus & Decadence HE	36
Opulence Plus	37
Expression Plus	38
Sophia Suite.....	39
Calibre BF	40

Outsets & Freestanding Fires



Renaissance Page 48

Emberglow & Emberglow Balanced Flue.....	41
Renoir	42
Regent LFE	43
Regent.....	44
Welcome.....	45
Strata	46
Misermatic.....	47
Renaissance.....	48
Firenza.....	49
Thurcroft Stove	50

Builders' Opening Sizes	51
-------------------------------	----

high efficiency

Open Fronted Plus

Open fronted HE fires provide the look and feel of a real open fire with net efficiencies of up to 74%. This type of fire provides both radiant and convected heat. Radiant heat is emitted from the coal or pebble fuel effect and the convected heat is generated by cool air drawn into the base of the fire which passes through a heat exchanger and is then emitted as warm air through the gap above the canopy.

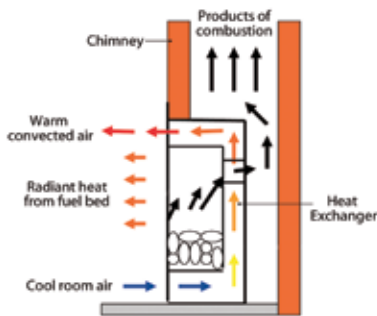

74% net efficiency



Richmond Plus in brass page 35

Windsor Contemporary Plus.....	18
Windsor Traditional Plus.....	19
Stirling Plus.....	22
Calypso Plus.....	30
Rhapsody Plus.....	31
Kenilworth Plus.....	32
Linear Plus.....	33
Caress Plus.....	34
Richmond Plus.....	35
Decadence Plus.....	36
Opulence Plus.....	37
Expression Plus.....	38

Glass Fronted High Efficiency

This type of high efficiency fire has a glass panel across the front of the fire which radiates the heat generated from the fuel effect directly into the room. The glass panel concentrates the radiant heat so that more heat is forced into the room and less is lost through the chimney. Combined with convected heat which is produced by cool air drawn into the base of the fire through the heat exchanger and then emitted as warm air through the gap above the canopy, this makes glass fronted HE's the most efficient conventional flue fires available.

Hearth Mounted

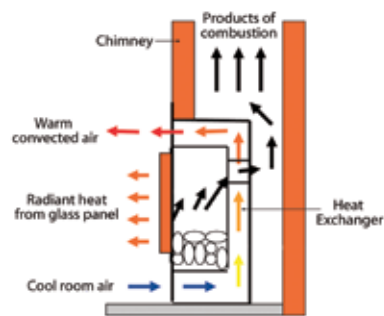

89% net efficiency



Caress HE in brass page 34

Windsor Contemporary HE.....	18
Windsor Traditional HE.....	19
Kenilworth HE.....	32
Linear HE.....	33
Caress HE.....	34
Decadence HE.....	36
Sophia.....	39

Hole in the Wall

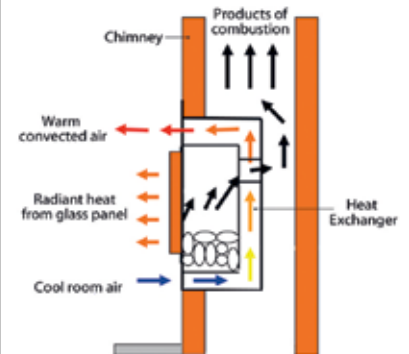

71% net efficiency



Kamina in black page 13

Castelle.....	9
Windsor Wall Mounted.....	11
Curve.....	12
Kamina.....	13
Expression HE.....	14
Diamond HE.....	15
Rocco.....	16
Jazz.....	17

Flavel has always had a reputation as a manufacturer of some of the most efficient fires on the market. Now we have set new industry standards with the introduction of the Flavel HE high efficiency range: exceptional heat output combined with lower running costs compared to standard gas fires.

Flavel's R&D team has invested in developing the technology to meet the key objective of producing gas fires that save energy and as a result, help to keep costs down.

Get up to
94%
net efficiency
from your gas fire...

Outset High Efficiency

Living Flame Effect

This type of fire sits on the hearth rather than being inset into the chimney. They are glass fronted and work much in the same way as any inset glass fronted fire but with glass panels on both the front and sides of the appliance there is a much larger area of radiant heat generated from the fuel effect.

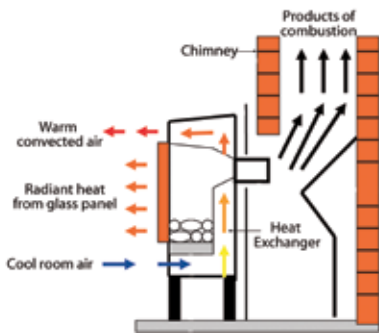

Radiant

Outset radiant fires produce both radiant and convected heat. They feature ceramic radiant plaques instead of a coal or pebble effect fuel effect. As they suggest, the ceramic radiant plaques generate radiant heat which is emitted directly into the room. Convected heat is produced by cool air drawn into the base of the fire, through the heat exchanger and then emitted as warm air through the gap at the top of the heater.

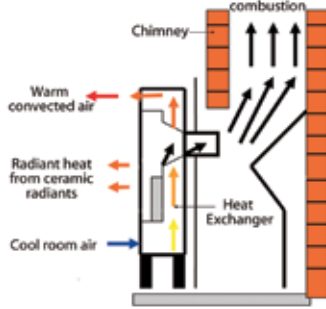

Balanced Flue High Efficiency

Balanced flue fires are designed for those who want all the benefits of a gas fire but don't have a built in chimney or flue in their home. A balanced flue fire comes with its own flue terminal which is vented directly through an outside wall. They are glass fronted, completely room sealed appliances and work by drawing and venting external air via a pair of co-axial tubes into the fire for combustion purposes. The radiant heat generated from the fuel-bed combines with convected heat, which is produced by cool air drawn into the base of the fire through the heat exchanger and then emitted as warm air through the gap above the canopy, making balanced flues one of the most efficient types of gas fires available.

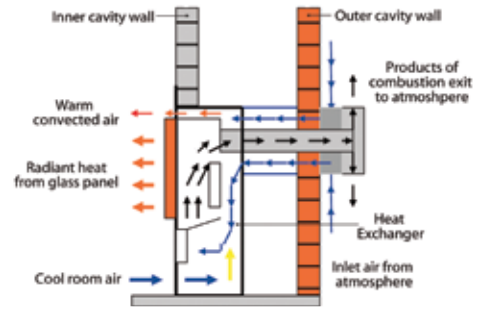

78% net efficiency



Emberglow in black page 41

Emberglow 41
Renoir 42

84% net efficiency



Strata in brown page 46

Regent.....44
Welcome.....45
Strata46
Misermatic.....47
Renaissance.....48
Firenza.....49

94% net efficiency



Calibre Balanced Flue in silver page 40

Rocco Balanced Flue..... 16
Jazz Balanced Flue 17
Raglan Balanced Flue..... 25
Orchestra Balanced Flue..... 26
Atlanta Balanced Flue 27
Calibre Balanced Flue..... 40
Emberglow Balanced Flue 41

Guide to icons

Type of Chimney or Flue

The type of chimney or flue you have dictates the type of fire you can have. But if you're not sure, then take a look at your roof and compare it with the simple guide below. It's worth remembering that a full depth fire often requires a traditional chimney or rebate on the fire surround, whilst a slimline fire will fit virtually any chimney or flue.



Brick Chimney - Class 1 Flues

Apart from products designed for "no chimney" applications, all Flavel products will fit brick chimneys. They are easily recognisable by a chimney stack with accompanying terracotta pot or gas terminal.



Pre-Fabricated Flue - Class 2 Flues

Pre-fabricated flues are easily identifiable by a metal flue and terminal on the roof and a metal flue box behind the fire.



Pre-Cast Flue

Pre-cast flues can be identified by a ridge vent or metal flue tube and terminal on the roof. Constructed from concrete or clay blocks they form a rectangular section flue. All Flavel fires featuring this icon are only suitable for Pre-Cast flues conforming to BS EN 1858.

Can't see a Chimney or Flue?

If you can't see a chimney or flue like the ones described on the left, then you will require either a Balanced Flue or a Powerflue.



Powerflue

Powerflue fires use an electronically driven fan unit mounted on the external wall to expel the flue gases directly outside the building.



Balanced Flue

Balanced Flue fires use a horizontal pipe to vent directly outside. An electricity supply is not required for Balanced Flue products.

Controls



Manual Control

A simple and discreet control system located behind the fire's trim or fret on inset fires and the bottom right side on outsets.



Semi Remote Control

Light the fire using the manual control system then use the remote control handset to adjust the flame height and heat output.



Slide Control

Convenient control that eliminates the necessity of bending down.



Electronic Flame Control

Discreet easy access buttons are used to ignite the fire and adjust heat and flame height.



Switch Control

Instant heat at the flick of a switch.



Remote Control with Thermostat

The remote control handset can be used to light the fire as well as to adjust the flame height and heat output. In addition, the handset contains the extra benefit of a thermostatic control to regulate room temperature and a programmable timer that can be pre-programmed to ensure your room will be warm whenever you wish.



Top Control

A push down and twist ignition and control located on the top of outset fires means you don't have to bend down to light the fire.



Remote Control

The remote control handset is used to light the fire as well as adjust the flame height and heat output.



Electronic Top or Side Control System

Both ignition and heat are controlled by a single rotary motion to light the fire. These easy to use controls are now available on our best selling radiant outsets. Requires an AA battery.

Power Supply

Your gas supply will either be natural gas or LPG, depending on the area in which you live.



Natural Gas

If you have a gas meter then you will have natural gas.



LPG

LPG is the most popular alternative to natural gas.

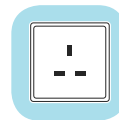

Electric

Simply plug in to your existing household electricity supply.

Online video



Watch the video

Wherever you see this symbol, use the QR code scanner app on your smartphone or mobile device to watch a short video of this fire.

Our Flavel gas fire guarantee



Strata brown Page 46



Every model* carries the peace of mind of a 7 year guarantee and the reassurance of the Flavel Airwatch System on all living flame effect fires. This device immediately cuts off the gas supply in the unlikely event of the flame being extinguished through blockage.

* Electric fires come with a 2 year guarantee

Our 7 year guarantee is subject to terms & conditions including annual services carried out by a Gas Safe Register engineer and annual replacement of the oxy-pilot assembly (or thermocouple on balanced flue models).

Calculating your Flavel gas fires running costs

Despite rising fuel prices, natural gas remains the most common and one of the cheapest ways to heat your home. Since the cost of gas can differ depending on service provider, location and tariff we do not include estimated running costs for our products. However, you can estimate your own running costs easily using the following calculation:-

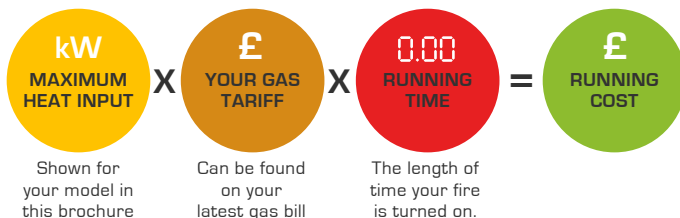

Example

What is the running cost of the Windsor Traditional HE when used for 3 hours at a cost of 4.2p per kilowatt hour?



Windsor Traditional HE brass Page 19



Flavel Fires Efficiency Guide

Whether your home has a brick chimney, pre-fabricated flue or pre-cast (BS EN 1858) flue you will be able to choose any fire from pages 8 to 38. We offer a huge range of products from radiant outsets to hole-in-the-wall fires. Your choice will depend on both the look and performance which is most suitable for you.

We offer a wide variety of products and each one offers different levels of energy efficiency. Depending on the style you would like, the hours of use, and the initial price you would like to pay, the most efficient gas fire may not always be the correct choice for you.

We have created the efficiency guide below to help you discover which type of fire is most suitable for you. We have clearly labelled each fire in this brochure to allow you to quickly and easily identify the level of efficiency that you can expect from that model.

Ultra High Efficiency Gas Fires - Net Efficiency 76%+

Ultra High Efficiency gas fires are exceptionally efficient and offer the largest energy cost saving per kilowatt of gas used to run the fire. These products tend to be glass fronted, radiant outset fires or balanced flue models. For more information about each of these product types see pages 4 and 5.

High Efficiency Gas Fires - Net Efficiency 66% to 75%

High Efficiency gas fires are very efficient and offer both style and performance. Many of these products are open fronted convectors, referred to as 'Plus' models in this brochure. They give you the look and feel of a real fire with maximum heat output. This category also includes some outset radiant heaters. For more information please see pages 4 and 5.

Standard Efficiency Gas Fires - Net efficiency 50% to 65%

Standard Efficiency gas fires can be used as a secondary heat source in conjunction with central heating. These products are ideal if you are looking for a great fireplace feature for occasional use.

Decorative Gas Fires - Net Efficiency up to 49%

These fires should be purchased for decorative purposes only and not used as a primary or secondary heat source. They provide a stunning focal point and help to create the ambiance of a real fire.



Castelle Slimline



High Efficiency



Hole in the Wall



Brick Chimney



Pre-Fabricated Flue



Pre-Cast Flue

Castelle Slimline

The Castelle Slimline has been specifically designed to fit a standard Pre-Cast flue without compromising style and performance. It features a striking curved black glass fascia, framing a beautifully realistic log fuel effect and a fully automatic remote control system.

Safety Features: Flame Supervision Device & Airwatch System

Specification		Control Options	Fire Back	Fuel Effect
Heat Input (max)	Heat Output (max)	Remote	Reflective	Log
5.0kW	3.1kW	✓	✓	✓
Net Efficiency		71%		

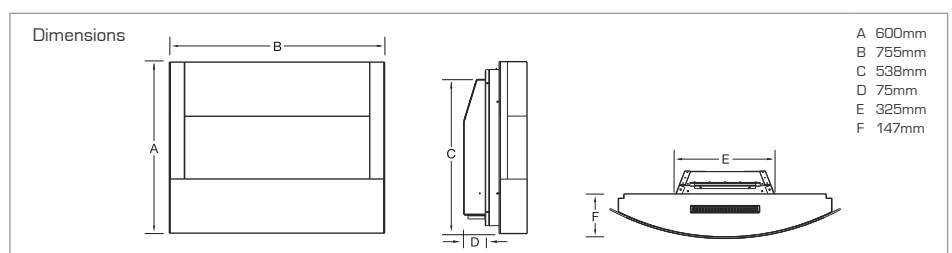

Finesse in brass



Standard Efficiency



Hole in the Wall



Finesse



Brick Chimney



Pre-Fabricated Flue



Pre-Cast Flue

The most versatile hole-in-the-wall gas fire from Flavel. The Finesse will fit virtually any flue and is available in three different variations – a brass trim option with coal fuel effect to suit a classical setting and a chrome trim option with a choice of coal or pebble fuel effect.

Safety Features: Flame Supervision Device & Airwatch System

Specification

Heat Input (max)	Heat Output (max)	Net Efficiency	Control Options	Fire Back	Fuel Effect		Colour Options		*Only available with coal fuel effect
			Manual	Plain	Coal	Pebble	Brass*	Chrome	
6.5kW	3.3kW	56%	✓	✓	✓	✓	✓	✓	✓

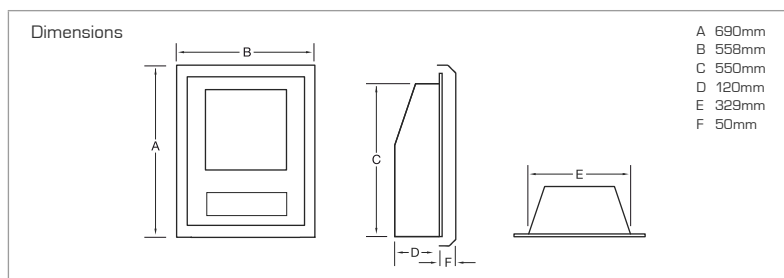

Finesse with coal fuel effect and chrome trim



Finesse with pebble fuel effect and chrome trim



Windsor Plus Wall Mounted



High Efficiency



Watch the video

Hole in the Wall



Windsor HE with coal fuel effect



Windsor Contemporary with pebble fuel effect



Brick Chimney

Pre-Fabricated Flue

Pre-Cast Flue

Windsor Contemporary Wall Mounted

The Windsor Wall Mounted is available in a choice of models including open-fronted, open-fronted 'Plus' and glass fronted 'HE'. Each model comes with the option of a coal or pebble fuel bed and features a large viewing window. This extremely versatile fire will fit into almost any chimney or flue.

Safety Features: Flame Supervision Device & Airwatch System

Specification

Model	Heat Input (max)	Heat Output (max)	Net Efficiency	Control Options	Fire Back	Fuel Effect	
				Manual	Plain	Coal	Pebble
Windsor Contemporary HE	4.0kW	3.2kW	89%	✓	✓	✓	✓
Windsor Contemporary Plus	6.5kW	4.1kW	70%*	✓	✓	✓	✓
Windsor Contemporary	6.5kW	3.3kW	56%	✓	✓	✓	✓

*BS7977-1:2009 has since been amended. If retested to the amended version of the standard the efficiencies and outputs of these fires may vary.

Dimensions

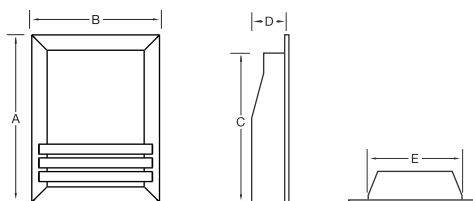

	Windsor Wall Mounted Contemporary HE	Windsor Wall Mounted Contemporary Plus	Windsor Wall Mounted Contemporary
A	671mm	671mm	671mm
B	512mm	512mm	512mm
C	550mm	548mm	550mm
D	125mm	120mm	120mm
E	327mm	324mm	329mm

Curve in black



High Efficiency



Wall Mounted

Curve



Brick Chimney



Pre-Fabricated Flue



Pre-Cast Flue

The Curve “hang-on-the-wall” fire with its sleek lines, textured fascia and glass front, complements the unique flame pattern created by an undulating back panel. This stunning fire is easy to install as it literally hangs on the wall, rather than slotting into the structure. The Curve is perfectly suited to contemporary homes requiring state-of-the-art appearance and the performance to match.

Safety Features: Flame Supervision Device & Airwatch System

Specification

Heat Input (max)	Heat Output (max)	Net Efficiency	Control Options	Fuel Effect	Colour Options	
			Remote	Flame Only	Black	Graphite Grey
6.5kW	4.0kW	71%	✓	✓	✓	✓

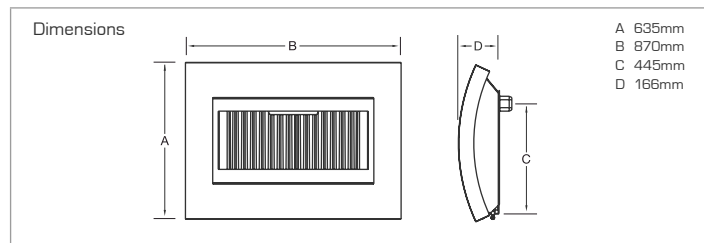

Curve in graphite grey



Kamina in black



High Efficiency



Wall Mounted



Brick Chimney



Pre-Fabricated Flue



Pre-Cast Flue

Kamina

The sleek black glass fascia on this “hang-on-the-wall” gas fire is perfectly complemented by the unique flame pattern created by an undulating back panel. Installation is virtually hassle free as this highly contemporary fire literally hangs on the wall, thereby minimising any costly or messy building work. With a maximum heat output of 4kW the Kamina is perfectly suited to contemporary homes requiring state-of-the-art appearance and performance.

Safety Features: Flame Supervision Device & Airwatch System

Specification			Control Options	Fuel Effect
Heat Input (max)	Heat Output (max)	Net Efficiency	Remote	Flame Only
6.5kW	4.0kW	71%	✓	✓

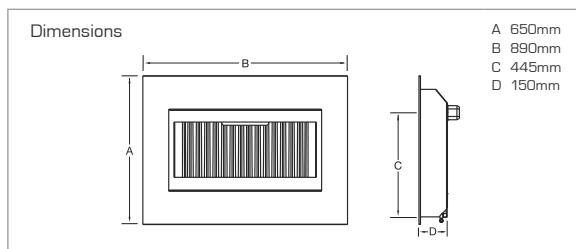

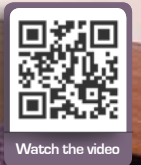

Hole in the Wall

Expression HE



Brick Chimney



Pre-Fabricated Flue



Pre-Cast Flue

The Flavel Expression HE hole in the wall high efficiency gas fire is a contemporary and economical heating solution with a net efficiency of 78%. This fully glass fronted model features a stunning stainless steel fascia design and is operated by a fully automatic remote control system.

Safety Features: Flame Supervision Device & Airwatch System

Specification			Control Options	Fuel Effect
Heat Input (max)	Heat Output (max)	Net Efficiency	Remote with Thermostat	Coal
4.5kW	3.2kW	78%	✓	✓

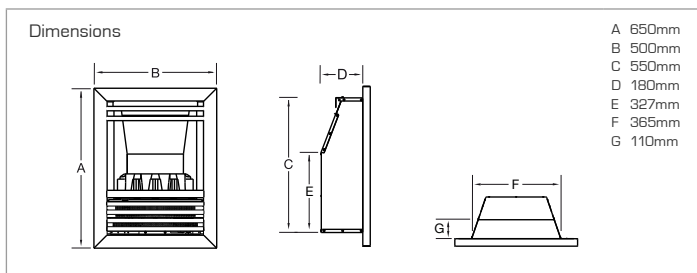



Diamond HE with coal fuel effect



Ultra High Efficiency



Hole in the Wall



Brick Chimney



Pre-Fabricated Flue

Diamond HE

As Flavel's debut high efficiency hole-in-the-wall fire, the Diamond HE is a contemporary and economical heating solution with a net efficiency of 78%. This fully glass fronted model features the stunning 'Diamond' fascia design and is available with a choice of coal or pebble fuel effect.

Safety Features: Flame Supervision Device & Airwatch System

Specification

Heat Input (max)	Heat Output (max)	Net Efficiency	Control Options	Fire Back	Fuel Effect	
			Remote with Thermostat	Plain	Coal	Pebble
4.5kW	3.2kW	78%	✓	✓	✓	✓



Diamond HE with pebble fuel effect

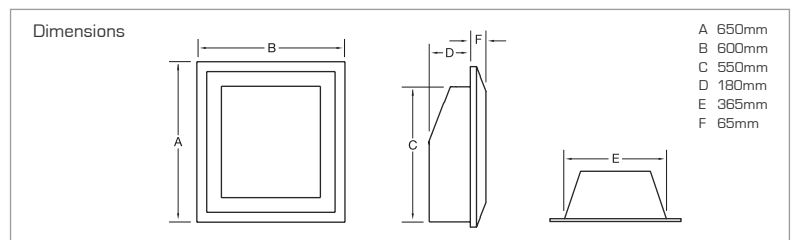

Rocco HE black back with silver trim

 Ultra High Efficiency



Hole in the Wall

Rocco HE



Brick Chimney



Pre-Fabricated Flue



Balanced Flue

This stunning glass fronted hole-in-the-wall fire features a realistic log fuel effect and comes in a range of fascia and back panel colour combinations.

Safety Features: Flame Supervision Device & Airwatch System (not applicable to balanced flue models)

Specification

	Heat Input (max)	Heat Output (max)	Net Efficiency	Control Options		Fire Back	Fuel Effect	Colour Options			
				Semi Remote	Remote	Ribbed	Log	Black back		Cream back	
								Black	Silver	Champagne	Champagne
Rocco HE	5.4kW	4.2kW	87%		✓	✓	✓	✓	✓	✓	✓
Rocco BF	7.5kW	5.5kW	87%	✓		✓	✓	✓	✓		✓



Rocco HE black back with black trim



Rocco HE cream back with champagne trim



Rocco HE black back with champagne trim

Dimensions

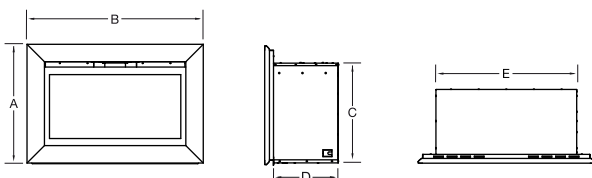

Rocco HE	Rocco BF
A 613mm	A 613mm
B 910mm	B 910mm
C 515mm	C 515mm
D 385mm	D 350mm
E 727mm	E 725mm



Jazz HE in black with black trim



Ultra High Efficiency



Hole in the Wall



Brick Chimney



Pre-Fabricated Flue



Balanced Flue

Jazz HE

This stunning glass fronted hole-in-the-wall fire has petite dimensions and a highly realistic log fuel effect. The Jazz HE black back model comes complete with high quality trims in three finishes – silver, champagne and black.

The Jazz cream back is complemented by a champagne trim. Jazz Balanced Flue features a black back with a choice of silver or black trim.



Jazz black back with silver trim



Jazz cream back with champagne trim

Safety Features: Flame Supervision Device & Airwatch System (not applicable to balanced flue models)

Specification

	Heat Input (max)	Heat Output (max)	Net Efficiency	Control Options		Fire Back	Fuel Effect	Colour Options			
				Semi Remote	Remote	Ribbed	Log	Black back		Cream back	
Jazz HE	4.4kW	3.5kW	87%								
Jazz BF	5.5kW	4.2kW	84%								

Dimensions

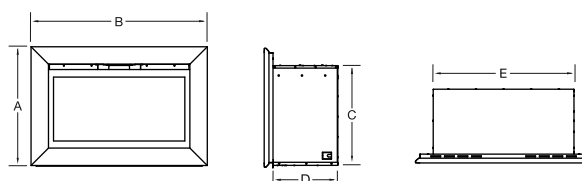

Jazz HE	Jazz BF
A 549mm	A 549mm
B 810mm	B 810mm
C 460mm	C 460mm
D 315mm	D 295mm
E 631mm	E 631mm

Windsor Contemporary Plus with pebble fuel effect



High Efficiency



Watch the video

Slimline

Windsor Contemporary



Brick Chimney



Pre-Fabricated Flue



Pre-Cast Flue

Stunning styling makes the Windsor Contemporary the centrepiece of your room. This slimline gas fire will fit almost any chimney or flue, including Pre-Cast (BS EN 1858) and is available as a glass fronted HE (high efficiency), open-fronted Plus or the standard open fronted model.

Safety Features: Flame Supervision Device & Airwatch System

Specification

Model	Heat Input (max)	Heat Output (max)	Net Efficiency	Control Options	Fire Back	Fuel Effect			Colour Options		
				Manual	Plain	Coal	Pebble	Driftwood	Brass	Polished Silver	Brushed Silver
Windsor Contemporary HE	4.0kW	3.2kW	89%	✓	✓	✓	✓		✓	✓	
Windsor Contemporary Plus	6.5kW	4.1kW	70%*	✓	✓	✓	✓			✓	
Windsor Contemporary	6.5kW	3.3kW	56%	✓	✓	✓	✓	✓	✓**	✓	✓

*BS7977-1:2009 has since been amended. If retested to the amended version of the standard the efficiencies and outputs of these fires may vary. **Not available with pebble fuel effect.



Windsor Contemporary HE with silver trim and coal fuel effect



Windsor Contemporary with brass trim and coal fuel effect



Windsor Contemporary with silver trim and driftwood fuel effect

Dimensions	Diagram 1		Diagram 2		Diagram 3	
	A	B	C	D	E	
Windsor Contemporary HE	592mm	475mm	550mm	125mm	327mm	
Windsor Contemporary Plus	592mm	475mm	548mm	120mm	324mm	
Windsor Contemporary	592mm	475mm	550mm	120mm	329mm	



Windsor Traditional in brass



Standard Efficiency



Watch the video

Slimline



Windsor Traditional HE in silver



Windsor Traditional Plus in brass



Windsor Classic in silver



Brick Chimney



Pre-Fabricated Flue



Pre-Cast Flue

Windsor Traditional & Classic

The Windsor Traditional is available as a standard radiant model, glass fronted HE model and also the open fronted plus platform. Each model offers exceptional heat output and is available in manual control. The Windsor Traditional HE is available in Slide control. The more modern Windsor classic is available in brass or silver with an attractive Grace Fret.

Safety Features: Flame Supervision Device & Airwatch System

Specification

Model	Heat Input (max)	Heat Output (max)	Net Efficiency	Control Options		Fire Back Design		Fuel Effect	Colour Options	
				Manual	Slide	Plain	Brick	Coal	Brass	Silver
Windsor Traditional HE	4.0kW	3.2kW	89%	✓	✓	✓		✓	✓	✓
Windsor Traditional Plus	6.5kW	4.1kW	70%*	✓		✓		✓	✓	
Windsor Traditional	6.5kW	3.3kW	56%	✓		✓	✓	✓	✓	✓
Windsor Classic	6.5kW	3.3kW	56%	✓		✓		✓	✓	✓

*BS7977-1:2009 has since been amended. If retested to the amended version of the standard the efficiencies and outputs of these fires may vary.

Dimensions	Windsor Traditional HE	Windsor Traditional Plus	Windsor Traditional & Classic
A	592mm	A 592mm	A 592mm
B	475mm	B 475mm	B 475mm
C	550mm	C 548mm	C 550mm
D	125mm	D 120mm	D 120mm
E	327mm	E 324mm	E 329mm

Melody in silver



Standard Efficiency



Slimline

Melody



Brick Chimney



Pre-Fabricated Flue



Pre-Cast Flue

The Melody is an elegant slimline fire enabling installation in almost any flue including pre-cast. The discreet slide control ensures convenient operation with a heat output of up to 3.3kW.

Melody in brass and black



Melody in black



Melody in brass



Safety Features: Flame Supervision Device & Airwatch System

Specification

Heat Input (max)	Heat Output (max)	Net Efficiency	Control Options	Fire Back	Fuel Effect	Colour Options			
			Slide	Plain	Coal	Brass	Brass and Black	Black	Silver
6.5kW	3.3kW	56%	✓	✓	✓	✓	✓	✓	✓

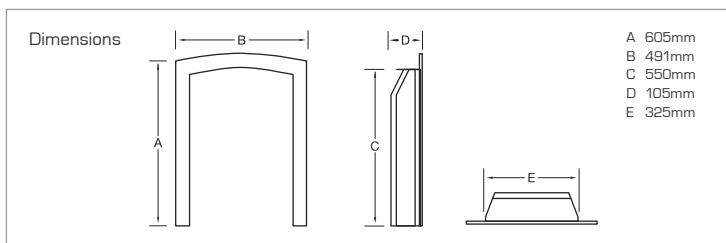

Warwick in brass



Standard Efficiency



Slimline



Brick Chimney



Pre-Fabricated Flue



Pre-Cast Flue



Powerflue

Warwick & Warwick Powerflue



Warwick with black trim and Balmoral black fret



Warwick with silver trim and Grace silver fret

This ultra slim Warwick gas fire will fit almost any chimney or flue, and has an impressive 3.3kW heat output.

Safety Features: Flame Supervision Device & Airwatch System

Specification

Model	Heat Input (max)	Heat Output (max)	Net Efficiency	Control Options	Fire Back	Fuel Effect	Colour Options		
				Manual	Plain	Coal	Brass	Black	Silver
Warwick	6.5kW	3.3kW	56%	✓	✓	✓	✓	✓	✓
Warwick Powerflue	6.5kW	3.2kW		✓	✓	✓	✓	✓	✓

Dimensions

Warwick Slimline

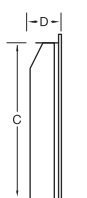
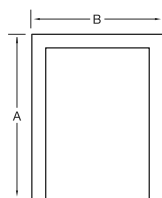

- A 595mm
- B 500mm
- C 550mm
- D 100mm
- E 325mm



Warwick Powerflue

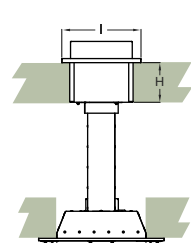
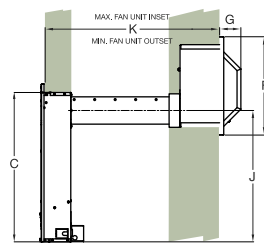

- A 595mm
- B 500mm
- C 547mm
- D 155mm
- E 326mm
- F 360mm
- G 78mm
- H 145mm
- I 290mm
- J 481mm
- K Inset
400 - 650mm
Outlet
250 - 500mm*

*Maximum flue length 5 metres and 3 bends.

Stirling Plus in black



High Efficiency



Watch the video

Slimline

Stirling Plus



Brick Chimney



Pre-Fabricated Flue



Pre-Cast Flue

The Stirling Plus open fronted high efficiency slimline gas fire will fit into all flue types and, with a very impressive heat output of 4.1kW, is sure to be a popular choice. The Stirling Plus is operated by a choice of manual or EFC control and is available in either a black or brass finish.

Safety Features: Flame Supervision Device & Airwatch System

Specification

Heat Input (max)	Heat Output (max)	Net Efficiency	Control Options		Fire Back	Fuel Effect	Colour Options	
			Manual	EFC	Plain	Coal	Brass	Black
6.5kW	4.1kW	70%*	✓	✓	✓	✓	✓	✓

*BS7977-1:2009 has since been amended. If retested to the amended version of the standard the efficiencies and outputs of these fires may vary.

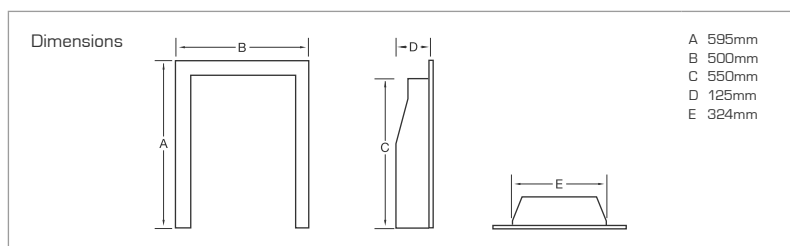

Stirling Plus with brass trim and Dallas antique fret



Caress Slimline manual control in brass



Coal effect and flame picture differs on slide control model

Slimline



Brick Chimney



Pre-Fabricated Flue



Pre-Cast Flue

Caress Slimline

The Caress Slimline gas fire features a fabulous, top quality cast trim and Blenheim fret in a choice of solid cast brass or polished silver cast iron.

Safety Features: Flame Supervision Device & Airwatch System

Specification

Model	Heat Input (max)	Heat Output (max)	Net Efficiency	Control Options		Fire Back	Fuel Effect	Colour Options	
				Manual	Slide	Plain	Coal	Brass	Silver
Caress Slimline	6.5kW	3.3kW	56%	✓	✓	✓	✓	✓	✓



Caress Slimline Slide Control in polished cast iron

Dimensions

Caress Slimline Manual Control	Caress Slimline Slide Control
A 615mm	A 615mm
B 510mm	B 510mm
C 550mm	C 550mm
D 120mm	D 105mm
E 329mm	E 325mm

SHOWROOM EXCLUSIVE

Decadence HE Slimline

High Efficiency



Watch the video

Slimline

Decadence HE Slimline



Brick Chimney



Pre-Fabricated Flue



Pre-Cast Flue

The Decadence Slimline HE high efficiency gas fire boasts an amazing 89% net efficiency and will fit almost any chimney or flue, including Pre-cast (BS EN 1858). This fully glass fronted model is available with a realistic coal fuel effect and is available in a choice of gold, silver or black nickel finishes.

Safety Features: Flame Supervision Device & Airwatch System

Specification			Control Options	Fire Back	Fuel Effect	Colour Options		
Heat Input (max)	Heat Output (max)	Net Efficiency						
4.0kW	3.2kW	89%	Manual	Plain	Coal	Gold	Silver	Black Nickel
			✓	✓	✓	✓	✓	✓

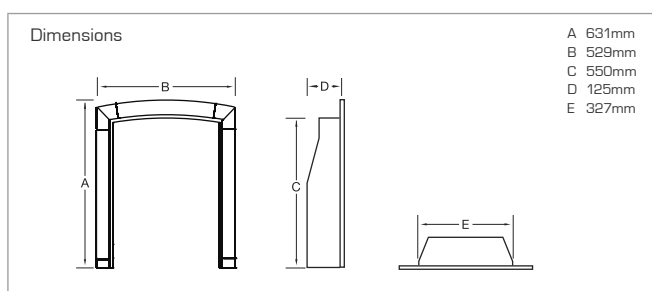

Decadence HE in gold



Decadence HE in black nickel



Raglan Balanced Flue in brass



Ultra High Efficiency



Slimline



Balanced Flue

Raglan Balanced Flue

With a net efficiency of 80% the stylish Raglan Balanced Flue is designed to fit into houses without a chimney or flue and its glass front does more than simply look great, it increases efficiency too.

Safety Features: Flame Supervision Device

Specification

Heat Input (max)	Heat Output (max)	Net Efficiency	Control Options	Fire Back	Fuel Effect	Colour Options
3.8kW	2.8kW	80%	Manual <input checked="" type="checkbox"/>	Plain <input checked="" type="checkbox"/>	Coal <input checked="" type="checkbox"/>	Brass <input checked="" type="checkbox"/> Silver <input checked="" type="checkbox"/>



Raglan Balanced Flue in silver

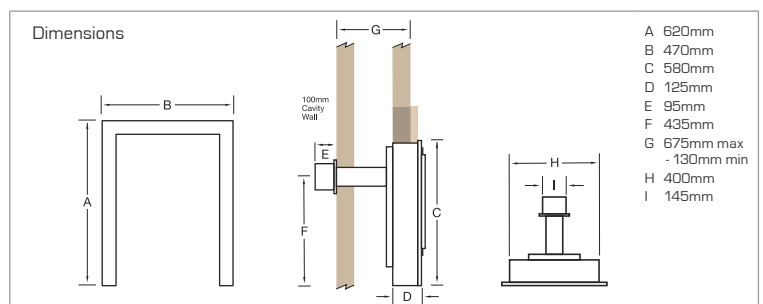

Orchestra Balanced Flue in silver



Ultra High Efficiency



Image shown represents the Orchestra natural gas model. Flame picture may differ on LPG model.

Slimline

Orchestra Balanced Flue



Balanced Flue

If you want the warmth and mood created by a living flame fire yet don't have a chimney or flue, then the Orchestra is the perfect solution. This neat, glass fronted inset fire with a net efficiency of 80% is framed by a chamfered trim and sleek fret.

Safety Features: Flame Supervision Device

Specification

Heat Input (max)	Heat Output (max)	Net Efficiency	Fuel Options		Control Options	Fire Back	Fuel Effect	Colour Options	
			Natural Gas	LPG	Manual	Plain	Coal	Brass	Silver
3.8kW	2.8kW	80%	✓	✓	✓	✓	✓	✓	✓

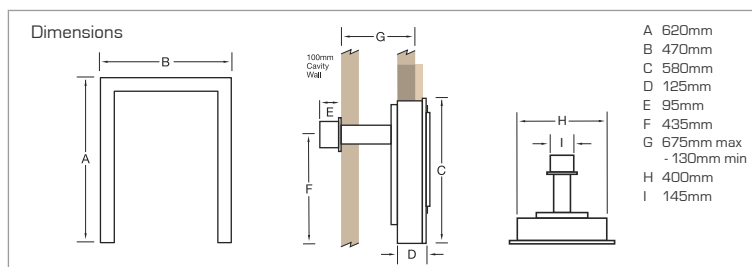

Orchestra Balanced Flue in brass



Atlanta Balanced Flue in silver



High Efficiency



Slimline



Balanced Flue

Atlanta Balanced Flue

Simplicity of form. Complexity of flame. The Atlanta's clean lines compliment its clean burning efficiency. The glass front amplifies a unique flame pattern through an undulating back panel. Offset against a brushed steel trim it conjures up an ethereal yet comforting minimalism.

Safety Features: Flame Supervision Device

Specification

Control Options

Fuel Effect

Heat Input (max)	Heat Output (max)	Net Efficiency	Manual	Flame Only
4.0kW	2.8kW	66%	✓	✓

Dimensions

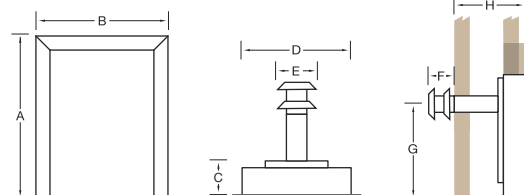

- A 622mm
- B 485mm
- C 125mm
- D 400mm
- E 245mm
- F 215mm
- G 435mm
- H 675mm max - 130mm min

Online inspiration & information

Tap into a wealth of knowledge and discover everything you need to know about purchasing, fitting and servicing your Flavel fire.

- Use our intelligent search tools to find your perfect gas fire
- Find your nearest Flavel Approved Stockist
- Download Installation and User manuals
- Register your guarantee
- Watch videos of our stunning fires
- Instant Live Chat facility on the website
- Interactive updated Blogs to keep you informed and intrigued

www.flavelfires.co.uk

FLAVEL

At the heart of your home



Waverley with inset tray



Decorative



Fret not included

Full Depth



Brick Chimney



Pre-Fabricated Flue

Waverley

The Waverley, with its beautiful decorative flame effect, is a perfect replacement for a solid fuel grate. The 16" tapered inset tray is designed to fit a standard 16" fire back, providing a realistic coal effect for almost any style of fireplace.

Safety Features: Flame Supervision Device & Airwatch System

Specification

Heat Input (max)	Heat Output (max)	Control Options	Fuel Effect
6.9kW	2.0kW	Manual Coal	Coal
		✓	✓

Dimensions

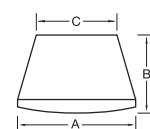

A 350mm
B 205mm
C 230mm



Full Depth

Calypso



Brick Chimney



Pre-Fabricated Flue



Pre-Cast Flue*

The Calypso successfully combines exceptional fire design with today's necessity for convenience in the form of a user friendly dual directional slide control. This fire will be equally at home in a contemporary or traditional fire surround and room setting.

Safety Features: Flame Supervision Device & Airwatch System

Specification

Model	Heat Input (max)	Heat Output (max)	Net Efficiency	Control Options		Fuel Effect
				Slide	Plain	Coal
Calypso	6.9kW	3.9kW	65%	✓	✓	✓
Calypso Plus	6.9kW	4.4kW	70%*	✓	✓	✓

*BS7977-1:2009 has since been amended. If retested to the amended version of the standard the efficiencies and outputs of these fires may vary.

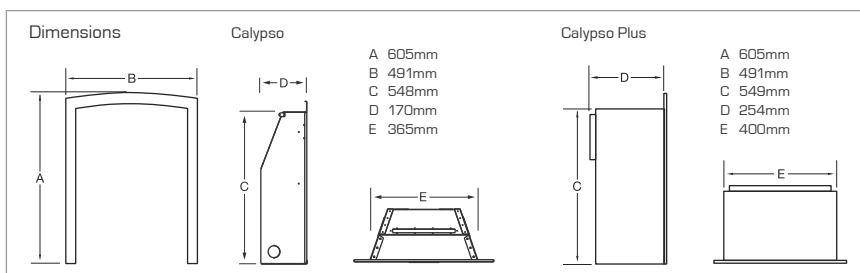

*Calypso Plus only.



Calypso



Rhapsody Plus in silver



High Efficiency



Full Depth



Rhapsody in black



Rhapsody in silver



Rhapsody Plus in brass and black



Brick Chimney



Pre-Fabricated Flue



Pre-Cast Flue*

Rhapsody

The classic Rhapsody open fronted fire has a very realistic full depth fuel effect and beautiful flame picture making it indistinguishable from a real coal fire. With its elegant arched trim and striking fret the Rhapsody is a timeless classic.

Safety Features: Flame Supervision Device & Airwatch System

Specification

Model	Heat Input (max)	Heat Output (max)	Net Efficiency	Fuel Options		Control Options		Fire Back	Fuel Effect	Colour Options			
				Natural Gas	LPG	Slide	Plain	Coal	Brass	Brass and Black	Black	Silver	
Rhapsody Plus	6.9kW	4.4kW	70%*	✓		✓		✓	✓	✓	✓	✓	✓
Rhapsody	6.9kW	4.0kW	65%	✓	✓	✓	✓	✓	✓	✓	✓	✓	✓

*BS7977-1:2009 has since been amended. If retested to the amended version of the standard the efficiencies and outputs of these fires may vary.

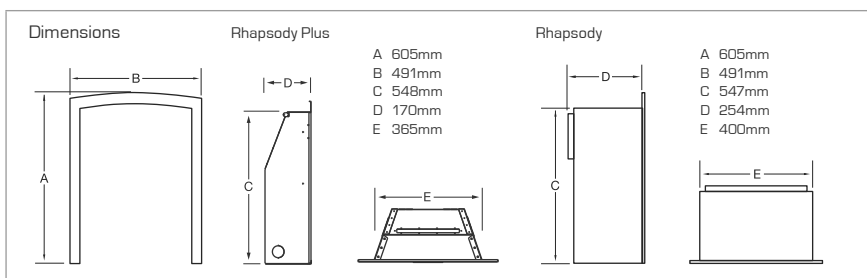

*Rhapsody Plus only.

Kenilworth Plus in brass with Balmoral fret



High Efficiency

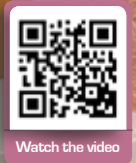

Full Depth

Kenilworth

Kenilworth Plus, HE & Powerflue



Brick Chimney



Pre-Fabricated Flue



Pre-Cast Flue



Powerflue

The Kenilworth gas fire features a welcoming full depth coal fuel effect and will fit most chimney and flue types including a precast flue with a 3" rebate on the fire surround.

Safety Features: Flame Supervision Device & Airwatch System

Specification

Model	Heat Input [max]	Heat Output [max]	Net Efficiency	Control Options			Fire Back	Fuel Effect	Colour Options			
				Manual	Slide	Remote	Plain	Coal	Balmoral		Grace	
									Brass	Black	Brass	Silver
Kenilworth HE	4.5kW	3.2kW	78%	✓		✓	✓	✓	✓		✓	
Kenilworth Plus	6.9kW	4.4kW	70%*	✓	✓	✓	✓	✓	✓		✓	
Kenilworth	6.9kW	3.3kW	53%	✓		✓	✓	✓	✓	✓	✓	
Kenilworth Powerflue	6.9kW	3.6kW		✓			✓	✓	✓	✓	✓	

*BS7977-1:2009 has since been amended. If retested to the amended version of the standard the efficiencies and outputs of these fires may vary.



Kenilworth HE in black



Kenilworth Plus in silver

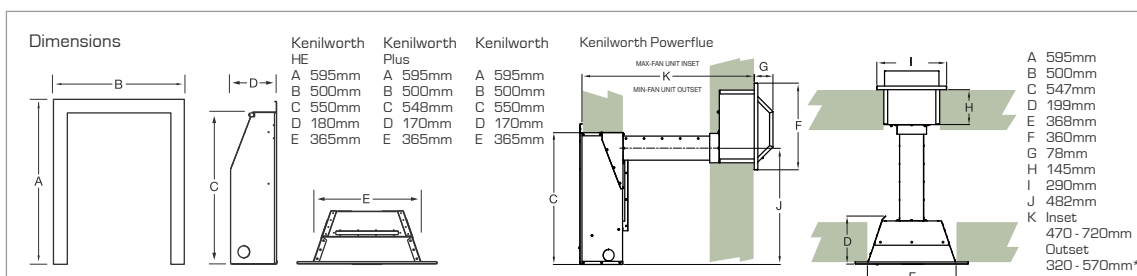

*Maximum flue length 5 metres and 3 bends.



Linear Plus with coal fuel effect



High Efficiency



Full Depth



Watch the video



Brick Chimney



Pre-Fabricated Flue



Pre-Cast Flue



Powerflue

Linear

Linear Plus, HE & Powerflue

The Linear is a stunning modern design with the combination of black ribbed back panels and polished silver fascia. This full depth gas fire delivers a wonderful flickering glow and can be installed into almost any chimney or flue including a pre-cast flue with a 3" rebated surround.

Safety Features: Flame Supervision Device & Airwatch System

Specification

Model	Heat Input (max)	Heat Output (max)	Net Efficiency	Control Options	Fuel Back	Fuel Effect		Colour Options
				Manual	Ribbed	Coal	Pebble	Polished Silver
Linear HE	4.5kW	3.2kW	78%	✓	✓	✓	✓	✓
Linear Plus	6.9kW	4.4kW	70%*	✓	✓	✓	✓	✓
Linear	6.9kW	3.3kW	53%	✓	✓	✓	✓	✓
Linear Powerflue	6.9kW	3.6kW		✓	✓	✓	✓	

*BS7977:12009 has since been amended. If retested to the amended version of the standard the efficiencies and outputs of these fires may vary.



Linear with pebble fuel effect



Linear HE with coal fuel effect

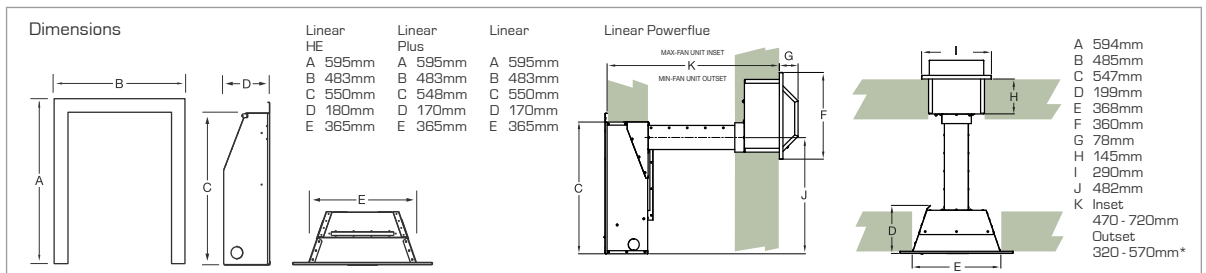

*Maximum flue length 5 metres and 3 bends.

Caress Plus Contemporary in silver



Standard Efficiency



*Images shown represents the Caress HE natural gas model. Flame picture may differ on LPG model.



Watch the video

Full Depth

Caress

Caress Plus & Caress HE



Brick Chimney



Pre-Fabricated Flue

The Caress full depth living flame effect convector gas fire boasts an impressive 4kW heat output (3.3kW on Plus model) and incredible efficiency. It is available in a choice of Traditional or Contemporary styling and both versions come in a choice of solid cast brass or polished silver cast iron.



Caress HE Traditional in silver



Caress Plus Traditional in brass



Caress Contemporary in brass

Safety Features: Flame Supervision Device & Airwatch System

Specification

Model	Heat Input (max)	Heat Output (max)	Net Efficiency	Fuel Options		Control Options			Fire Back	Fuel Effect	Colour Options			
				Natural Gas	LPG*	Manual	Slide	Remote			Plain	Coal	Traditional	
											Brass	Silver	Brass	Silver
Caress HE	5.0kW	4.0kW	89%	✓	✓	✓	✓	✓	✓	✓	✓	✓	✓	✓
Caress Plus	6.5kW	4.4kW	70%*	✓		✓	✓	✓	✓	✓	✓	✓	✓	✓
Caress	6.9kW	4.4kW	65%	✓		✓	✓	✓	✓	✓	✓	✓	✓	✓

*BS7977-1:2009 has since been amended. If retested to the amended version of the standard the efficiencies and outputs of these fires may vary.

Dimensions		Caress HE	Caress Plus	Caress Contemporary & Brass
A	615mm	A 615mm	A 615mm	A 615mm
B	510mm	B 510mm	B 510mm	B 510mm
C	550mm	C 548mm	C 550mm	C 550mm
D	230mm	D 170mm	D 250mm	D 250mm
E	400mm	E 365mm	E 400mm	E 400mm

*LPG model only available with manual control operation.



Richmond Plus in brass



High Efficiency



Full Depth



Watch the video



Brick Chimney



Pre-Fabricated Flue

Richmond & Richmond Plus

You can now achieve the look of a real open coal fire, combined with the convenience of gas fuel. The Richmond full depth convector fire combines a brilliant flame effect with high efficiency and outstanding warmth. The Richmond features a Profiled trim and Dallas fret and is available in black, silver or brass finishes.



Richmond Plus
in silver



Richmond
in black

Safety Features: Flame Supervision Device & Airwatch System

Specification

Model	Heat Input (max)	Heat Output (max)	Net Efficiency	Control Options			Fire Back	Fuel Effect	Colour Options		
				Manual	Slide	Remote	Plain	Coal	Brass	Black	Silver
Richmond Plus	6.9kW	4.6kW	74%*	✓	✓	✓	✓	✓	✓	✓	✓
Richmond	6.9kW	4.0kW	65%	✓	✓	✓	✓	✓	✓	✓	✓

*BS7971:2009 has since been amended. If retested to the amended version of the standard the efficiencies and outputs of these fires may vary.

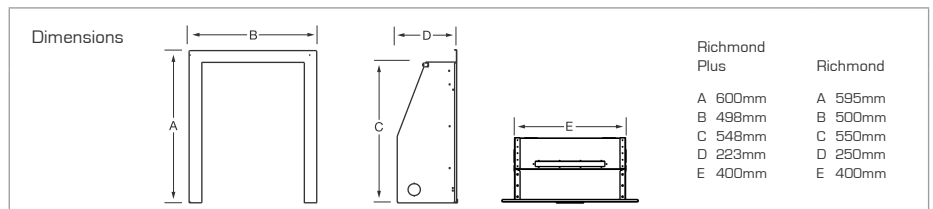

SHOWROOM EXCLUSIVE

Decadence Plus in black nickel



High Efficiency



Watch the video

Full Depth

Decadence Plus & Decadence HE



Brick Chimney



Pre-Fabricated Flue



Pre-Cast Flue

This striking open fronted full depth gas fire features a choice of three beautiful high quality cast iron fascia's available in a choice of Gold, Silver or Black Nickel plated finishes.

Safety Features: Flame Supervision Device

Specification

	Heat Input (max)	Heat Output (max)	Net Efficiency	Fuel Options	Control Options			Fire Back	Fuel Effect	Colour Options		
				Natural Gas	Manual	Slide	Remote with Thermostat	Plain	Coal	Gold	Silver	Black Nickel
Decadence Plus	6.9kW	4.4kW	70%*	✓	✓	✓	✓	✓	✓	✓	✓	✓
Decadence HE	4.5kW	3.2kW	78%	✓	✓		✓		✓	✓	✓	✓

*BS7977-1:2009 has since been amended. If retested to the amended version of the standard the efficiencies and outputs of these fires may vary.



Decadence HE in gold



Decadence HE in silver

Dimensions

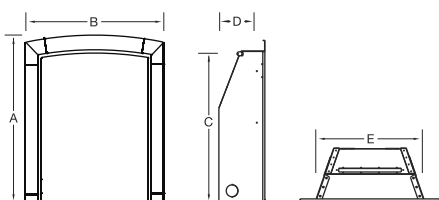

Decadence Plus	Decadence HE
A 631mm	A 631mm
B 529mm	B 529mm
C 550mm	C 550mm
D 170mm	D 180mm
E 365mm	E 365mm



Opulence Plus



High Efficiency

SHOWROOM EXCLUSIVE



Watch the video

Full Depth



Brick Chimney



Pre-Fabricated Flue



Pre-Cast Flue

Opulence Plus

The Flavel Opulence Plus high efficiency gas fire boast an impressive 70% net efficiency and can be installed in to almost any chimney or flue, include Pre-cast when fitted with a 3" rebated fire surround. This open-fronted gas fire features a highly realistic coal fuel effect and is available as a manual, easy flame or fully automatic remote controlled fire. The Opulence Plus comes in choice of brass or silver finishes.

Safety Features: Flame Supervision Device & Airwatch System

Specification			Power	Control Options			Fuel Effect	Colour Options	
Heat Input (max)	Heat Output (max)	Net Efficiency							
6.9kW	4.4kW	70%*	Natural Gas	Manual	EFC	Remote	Coal	Brass	Silver

*BS7977-1:2009 has since been amended. If retested to the amended version of the standard the efficiencies and outputs of these fires may vary.



Opulence in silver

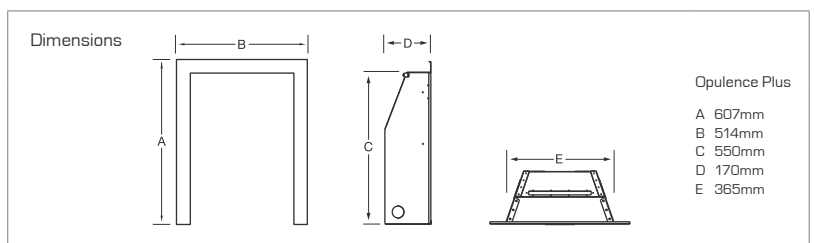

SHOWROOM EXCLUSIVE

Expression Plus



High Efficiency



Watch the video

Full Depth

Expression Plus



Brick Chimney



Pre-Fabricated Flue



Pre-Cast Flue

The Flavel Expression Plus high efficiency gas fire boast an impressive 70% net efficiency and can be installed in to almost any chimney or flue, include Pre-cast when fitted with a 3" rebated fire surround. This open-fronted gas fire features a coal fuel effect and comes with a contemporary stainless steel one-piece fascia. The Expression Plus is available with manual, slide, easy flame or fully automatic remote control.

Safety Features: Flame Supervision Device

Specification

Heat Input (max)	Heat Output (max)	Net Efficiency	Fuel Options		Control Options				Fuel Effect	Colour Options
			Natural Gas		Manual	Slide	EFC	Remote	Coal	
6.9kW	4.4kW	70%*	✓	✓	✓	✓	✓	✓	✓	Silver

*BS7977-1:2009 has since been amended. If retested to the amended version of the standard the efficiencies and outputs of these fires may vary.

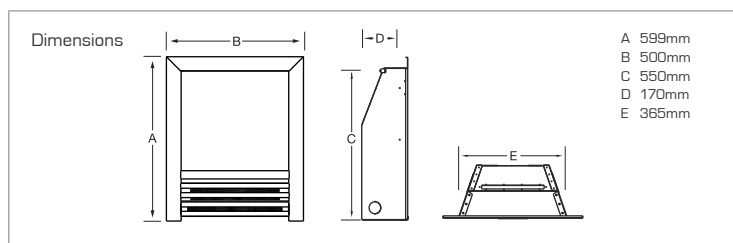



Sophia Suite



High Efficiency

SHOWROOM EXCLUSIVE



Watch the video

Full Depth



Brick Chimney



Pre-Fabricated Flue



Balanced Flue

Sophia Suite



Sophia Slimline
Balanced Flue

The Flavel Sophia gas fire suite features a large, high efficiency, log effect gas fire framed by a beautifully designed Royal Botticino stone surround. This gas fire suite is available in a conventional flue or slimline balanced flue version and is operated by a multifunctional remote control handset. The remote control system includes a thermostatic operation which automatically adjusts the heat output up or down to maintain your desired pre-set temperature. There is also a wake/sleep timer function which lets you specify when the fire will automatically turn on and turn off. For optimum efficiency the Sophia comes with a built in electronic fan that is used to circulate convected heat around the room.

Safety Features: Flame Supervision Device & Airwatch System (not applicable to balanced flue model)

Specification

	Heat Input (max)	Heat Output (max)	Net Efficiency	Fuel Options	Control Options	Fuel Effect
Sophia	7.6kW	4.8kW	70%	✓	✓	✓
Sophia Slimline Balanced Flue	5.5kW	4.3kW	87%	✓	✓	✓

Dimensions

Sophia Suite

A 1233mm E 1450mm I 200mm
B 1480mm F 792mm J 410mm
C 739mm G 921mm K 790mm
D 185mm H 352mm L 755mm

Sophia Slimline Balanced Flue

A 1232mm E 154mm I 694mm
B 1450mm F 410mm J 960mm
C 200mm G 746mm K 1450mm
D 1020mm H 550mm

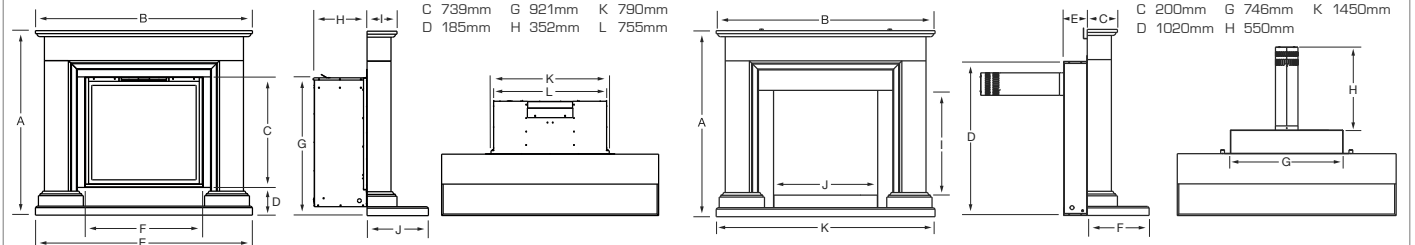

Calibre Balanced Flue in silver



Ultra High Efficiency



Full Depth

Image shown represents the Calibre natural gas model. Flame picture may differ on LPG model.

Calibre Balanced Flue



Balanced Flue

The Calibre Balanced Flue gas fire boasts a net efficiency of up to 94% and features a full depth coal fuel effect. This glass fronted fire has an exceptionally large viewing area and is available in a choice of brass or silver.

Safety Features: Flame Supervision Device

Specification

Specification			Fuel Options		Control Options			Fire Back	Fuel Effect	Colour Options	
Heat Input (max)	Heat Output (max)	Net Efficiency	Natural Gas	LPG*	Manual	EFC	Remote with Thermostat	Plain	Coal	Brass	Silver
4.6kW	4.3kW	94%	✓	✓	✓	✓	✓	✓	✓	✓	✓

*LPG only available on manual control models

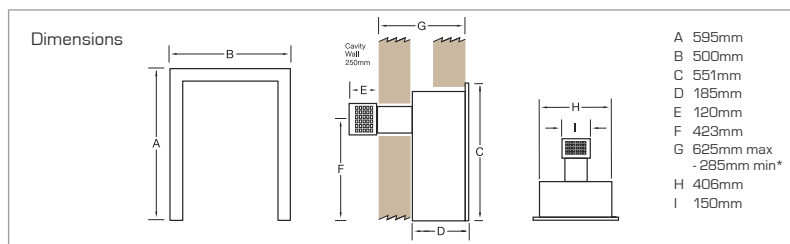

*Differs on EFC models. An optional flue extension is available to increase maximum length to 1015mm or manual and 973mm on EFC models.



Calibre Balanced Flue in brass



Emberglow



Ultra High Efficiency



Watch the video

Image shown represents the Emberglow natural gas model. Flame picture may differ on LPG model.

Outset



Brick Chimney



Pre-Fabricated Flue



Pre-Cast Flue



Balanced Flue

Emberglow & Emberglow Balanced Flue

The Emberglow ultra high efficiency outset gas fire features an elegant design with high quality cast iron canopy and fire front. With front and side windows the mesmerising dancing flames can be seen from all angles and it is operated by an easy to use electronic side control system.

Safety Features: Flame Supervision Device & Airwatch System (not applicable to balanced flue models)

Specification

Model	Heat Input (max)	Heat Output (max)	Net Efficiency	Fuel Options		Control Options			Fuel Effect
				Natural Gas	LPG	Electronic Side	Remote	Manual	Coal
Emberglow	6.0kW	4.3kW	78%	✓	✓	✓	✓		✓
Emberglow BF	5.25kW	3.94kW	87%	✓	✓			✓	✓



Emberglow Balanced Flue

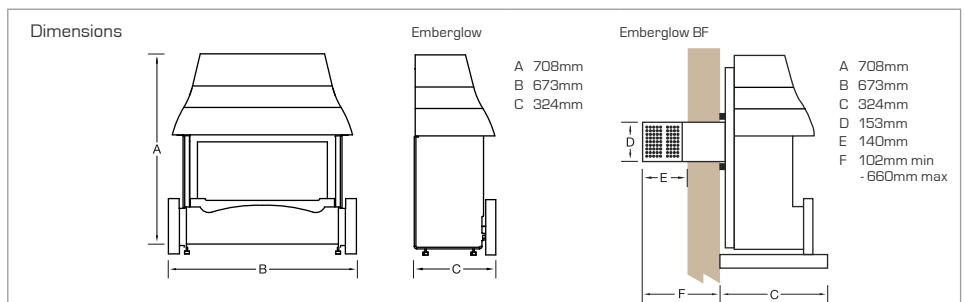

Renoir in black



Ultra High Efficiency



Outset

Renoir



Brick Chimney



Pre-Fabricated Flue



Pre-Cast Flue

The Renoir outset living flame effect gas fire features a beautiful flickering flame effect and is operated by an electronic side control system to make it much easier to ignite the fire. This classically designed fire has an impressive heat output of 4.3kW and a net efficiency of 78%.

Safety Features: Flame Supervision Device & Airwatch System

Specification

Heat Input (max)	Heat Output (max)	Net Efficiency	Control Options		Fuel Effect	Colour Options	
			Electronic Side	Remote	Coal	Black	Bronze
6.0kW	4.3kW	78%	✓	✓	✓	✓	✓

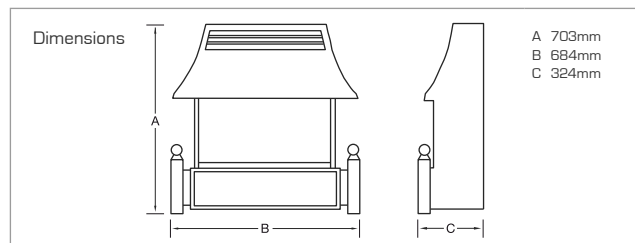

Renoir in bronze



Outlet



Brick Chimney



Pre-Fabricated Flue



Pre-Cast Flue

Regent LFE

One of the most popular radiant fires in the UK, The Regent LFE is slim for a neat fit into an existing fireplace and is highly efficient. It provides radiant and convected heat and is an elegant interpretation of the Regency period.

Safety Features: Flame Supervision Device & Airwatch System

Specification

Heat Input (max)	Heat Output (max)	Net Efficiency	Control Options		Fire Back Design	Fuel Effect	Colour Options	
			Electronic Side	Remote	Plain	Coal	Black	Bronze
6.0kW	3.2kW	60%	✓	✓	✓	✓	✓	✓



Regent LFE in bronze

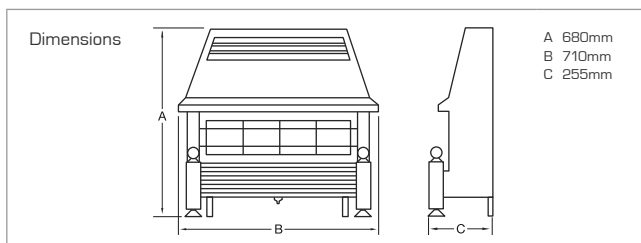

Regent in black



High Efficiency



Outset

Regent



Brick Chimney



Pre-Fabricated Flue



Pre-Cast Flue

One of the most popular radiant fires in the UK, the Regent features a slim design and has a net efficiency of 74%. The Regent is available in a choice of black or bronze finishes and is operated by electronic side control.

Safety Features: Flame Supervision Device & Airwatch System

Specification

Heat Input (max)	Heat Output (max)	Net Efficiency	Control Options	Colour Options	
			Electronic Side	Black	Bronze
6.6kW	4.4kW	74%	✓	✓	✓

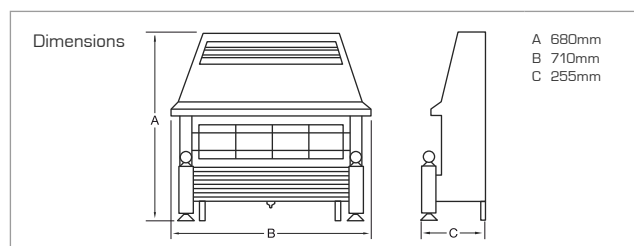

Regent in bronze



Welcome in bronze



Outlet



Brick Chimney



Pre-Fabricated Flue



Pre-Cast Flue

Welcome

The Welcome's beautiful electrically illuminated coal effect brings life to the room even when the heat is off, providing a charming focal point to any room. It is also highly efficient at 74% (net), resulting in lower running costs.

Safety Features: Flame Supervision Device & Airwatch System

Specification

Heat Input (max)	Heat Output (max)	Net Efficiency	Control Options	Colour Options	
			Electronic Side	Black	Bronze
6.6kW	4.4kW	74%	✓	✓	✓



Welcome in black

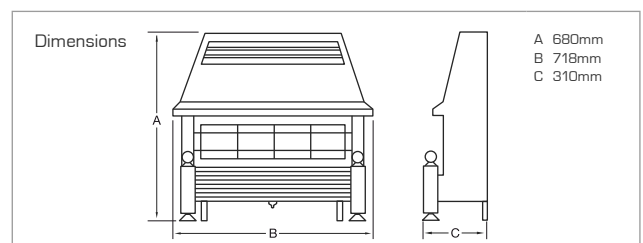

Strata in brown



Ultra High Efficiency



Watch the video

Outset

Strata



Brick Chimney



Pre-Fabricated Flue



Pre-Cast Flue

The Strata offers an incredible net efficiency of 84% and 5.2kW heat output. It has a stylish contemporary look with soft, curved lines and is available in a choice of four colour options.

Safety Features: Flame Supervision Device & Airwatch System

Specification

Model	Heat Input (max)	Heat Output (max)	Net Efficiency	Guarantee	Control Options		Colour Options			
					Electronic Top	Electronic Top	Black	Brown	Cream	White
Strata	6.9kW	5.2kW	84%	7 years	✓	✓	✓	✓	✓	✓

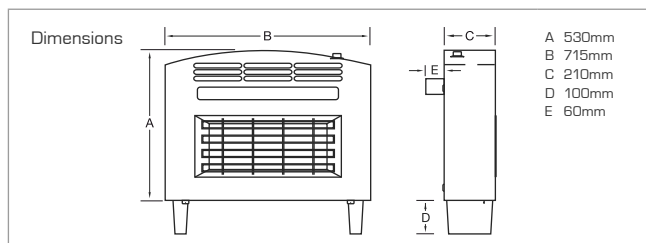

Strata in black



Strata in white



Strata in cream



Misermatic in light oak



Ultra High Efficiency



Outset



Brick Chimney



Pre-Fabricated Flue



Pre-Cast Flue

Misermatic

Incredible 84% net efficiency and adaptability; the Misermatic has them both. Available in a range of wood finishes, this fire can be wall or hearth mounted with an easily accessible top mounted control.



Misermatic in teak



Misermatic in medium oak



Misermatic in mahogany



Misermatic in black

Safety Features: Flame Supervision Device & Airwatch System

Specification

Model	Heat Input (max)	Heat Output (max)	Net Efficiency	Guarantee
Misermatic	6.9kW	5.2kW	84%	7 years

Control Options



Electronic Top

Colour Options



Teak Mahogany Light Oak Medium Oak Black

✓	✓	✓	✓	✓
---	---	---	---	---

Dimensions

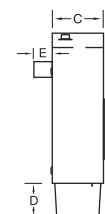
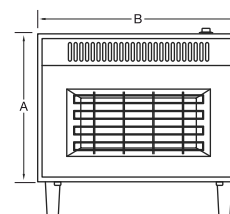

- A 515mm
- B 800mm
- C 200mm
- D 100mm
- E 60mm

Renaissance in silver



Ultra High Efficiency



Outlet

Renaissance



Brick Chimney



Pre-Fabricated Flue



Pre-Cast Flue

The Renaissance provides a natural talking point the moment you enter the room. Its stylish retro design is matched by its forward thinking simplicity of installation, impressive 5.2kW heat output and astounding 84% net efficiency.

Safety Features: Flame Supervision Device & Airwatch System

Specification

Model	Heat Input (max)	Heat Output (max)	Net Efficiency	Guarantee
Renaissance	6.9kW	5.2kW	84%	7 years

Control Options



Electronic Top

Colour Options



Black



Silver

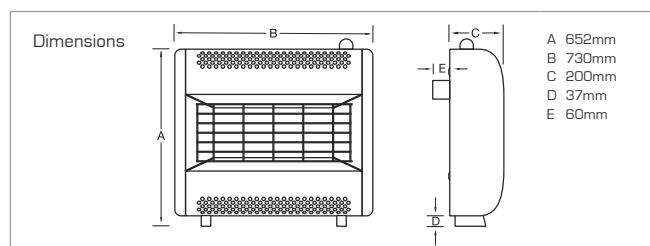

Renaissance in black



Firenza in bronze



High Efficiency



Outlet



Brick Chimney



Pre-Fabricated Flue



Pre-Cast Flue

Firenza

The compact and economical Firenza can be wall or hearth mounted and has a net efficiency of 74%. The control handle is located on the top panel for ease of use.



Firenza in black

Safety Features: Flame Supervision Device & Airwatch System

Specification

Heat Input (max)	Heat Output (max)	Net Efficiency
5.2kW	3.4kW	73%

Control Options

Top Control
✓

Colour Options

Black	Bronze
✓	✓

Dimensions

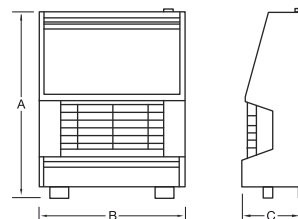

- A 658mm
- B 506mm
- C 222mm

Thurcroft Stove in black

Ultra High Efficiency



Freestanding

Thurcroft Stove



No Flue

The Thurcroft is a 100% efficient portable stove and the ideal mobile gas appliance with a living flame effect that provides the warmth, appearance and atmosphere of a traditional stove. A self contained 7kg Butane gas cylinder* housed within the body of the stove provides up to 60 hours burning time.

Safety Features: Flame Supervision Device & Airwatch System

Specification

Heat Input [max]	Heat Output [max]	Net Efficiency	Fuel Options Butane LPG	Control Options Manual	Fuel Effect Coal
2.6kW	2.6kW	100%	✓	✓	✓

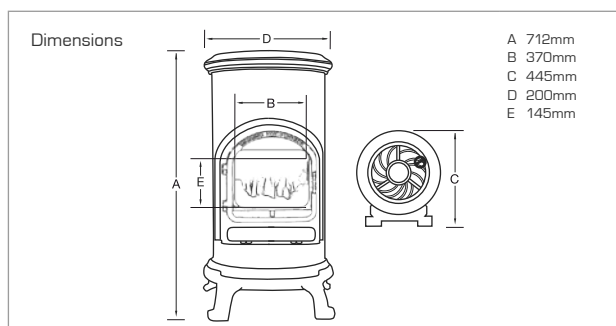

* Not included with the appliance.

For details on how to obtain a Butane gas cylinder please call 0870 241 1603 or visit www.calorgas.co.uk

Builders' Opening sizes

Product	Minimum Opening Width	Maximum Opening Width	Minimum Opening Height	Maximum Opening Height
Atlanta BF	410mm	420mm	550mm	560mm
Calibre BF	415mm	420mm	563mm	570mm
Calypso	400mm	450mm	550mm	570mm
Calypso Plus	370mm	440mm	550mm	570mm
Caress	400mm	450mm	550mm	570mm
Caress HE	400mm	450mm	550mm	570mm
Caress Plus	370mm	440mm	550mm	570mm
Caress Slimline SC	330mm	430mm	550mm	565mm
Caress Slimline MC	330mm	440mm	550mm	575mm
Castelle	350mm	400mm	490mm	500mm
Curve	300mm	440mm	300mm	440mm
Decadence HE	370mm	450mm	550mm	570mm
Decadence Plus	370mm	440mm	550mm	570mm
Decadence Slimline	330mm	440mm	550mm	575mm
Diamond HE	370mm	450mm	550mm	570mm
Emberglow	305mm	440mm	500mm	650mm
Expression HE	370mm	450mm	550mm	570mm
Expression Plus	370mm	440mm	550mm	570mm
Finesse	330mm	430mm	550mm	575mm
Firenza	305mm	440mm	510mm	650mm
Jazz HE	650mm	660mm	460mm	470mm
Jazz BF	635mm	645mm	465mm	475mm
Kamina	300mm	440mm	300mm	440mm
Kenilworth HE	370mm	450mm	550mm	570mm
Kenilworth Plus	370mm	440mm	550mm	570mm
Kenilworth inc PF	375mm	440mm	550mm	570mm
Linear HE	370mm	450mm	550mm	570mm
Linear inc PF	375mm	440mm	550mm	570mm
Linear Plus	370mm	440mm	550mm	570mm
Melody	330mm	430mm	550mm	565mm
Misermatic	305mm	440mm	580mm	650mm
Opulence Plus	370mm	440mm	550mm	570mm
Orchestra BF	410mm	420mm	555mm	565mm
Raglan BF	410mm	420mm	555mm	565mm
Regent	305mm	440mm	470mm	650mm
Regent LFE	305mm	440mm	525mm	650mm
Renaissance	305mm	440mm	580mm	650mm
Renoir	305mm	440mm	500mm	650mm
Rhapsody	400mm	450mm	550mm	570mm
Richmond	400mm	450mm	550mm	570mm
Rocco HE	750mm	760mm	520mm	530mm
Rocco BF	730mm	780mm	540mm	550mm
Sophia	760mm	790mm	870mm	880mm
Stirling Plus	330mm	440mm	550mm	575mm
Strata	305mm	440mm	580mm	650mm
Warwick inc PF	330mm	430mm	550mm	565mm
Waverley*	400mm	440mm	550mm	575mm
Waverley**	560mm	600mm	690mm	720mm
Welcome	305mm	440mm	470mm	650mm
Windsor	330mm	440mm	550mm	575mm
Windsor HE	330mm	440mm	550mm	575mm
Windsor Plus	330mm	440mm	550mm	575mm

*when fitted into standard builders opening with existing chair-brick

**when fitted with "Victorian" style casting



www.flavelfires.co.uk

Go direct to the Flavel website on your smart phone or tablet device, just scan in this QR code.

WARNING BFM Europe Limited is a Gas Safe Register company. We recommend that all of our fires are installed by Gas Safe Register engineers in accordance with our instructions, electric models by a competent person.

DISCLAIMER Our policy is one of constant development and improvement. We therefore reserve the right to revise designs and specifications of our products without formal notice, patents pending. We always recommend our products be viewed in an approved showroom before purchase.

Whilst we have taken every care in the preparation of this brochure it is not intended to replace the installation manual which provides more detailed information.

Photography is for illustration purposes only and although every effort has been made to ensure accurate reproduction of typical installations and flame pictures they may vary according to fire model and flue types.

We accept no liability for any loss or damage arising directly or indirectly from the use of this brochure.

We recommend that all our fires are used in conjunction with central heating and not as a primary source of heat.

In the interests of personal safety a suitable fireguard is recommended when children, the elderly and the infirm are present.

(This brochure is copyright 2016 and must not be reproduced in whole or in any part without prior written permission).

We would like to thank Kedleston Heating [01332 200303], Olde England Reproductions [01782 319350], Stanningley Firesides [0113 257 1512] and GB Mantles [01924 473243] for contributing fire surrounds to this brochure.



**MADE
IN BRITAIN**



Find us on Facebook,
Twitter, Pinterest & YouTube



At the heart of your home

BFM Europe Limited, Trentham Lakes, Stoke-on-Trent, Staffordshire ST4 4TJ.

Tel: 01782 339000. www.flavelfires.co.uk e-mail: info@bfm-europe.com