

Integra Collection



Efficient cast iron fireplaces for every home
Gas, Electric & Solid Fuel Options

Contents

Integra Castings

- 3 Anson Black HE
- 4 Anson Full Polish
- 5 Ashbourne
- 6 Oxford
- 7 Washington
- 8 Anson Black
- 9 Jesmond
- 10 Anson Half Polish
- 11 Majestic
- 12 Electric Suite
- 13 Solid Fuel Suite
- 14 Glen
- 15 Aston
- 16 Eden
- 17 Tiles & Sleeves

Gas Fires with Trims & Frets

- 18 Classic Multiflue
- 19 Convector
- 20 Powerflue
- 21 High Efficiency
- 22 Assembly Details & Dimensions
- 23 Gas Fire Specifications



There can be little else more inviting and comforting than the warmth and glow of a real coal fire inside a traditional cast-iron fireplace.

The Industrial Revolution launched the robust, practical and stylish cast-iron fireplace and it still remains with us today.

The open coal fires of yesteryear, however, were often replaced over the last few decades by inefficient decorative gas coal effect fires. What options do we have in today's greener and more efficient market? Well, we would like to introduce you to the Integra Collection.

Integra is a unique range of quality cast-iron inserts which integrate fully with some of the most efficient gas, solid fuel and electric fires on the market today. These fires, known as Integra Engines, can be fitted into almost any flue application.

We hope you enjoy your journey through our brochure.

Internet Policy

We do not recommend purchasing an Integra fireplace online as it can be a complex product to order, deliver, assemble and install. Professional advice and experience are advisable as every fireplace and fitting is unique and is governed by regulation.

For this reason Cast Tec and its distributors only supply reputable outlets that display Integra products in a showroom, provide suitably qualified staff and use Gas Safe or HETAS registered fireplace installers.

To locate your nearest Retailer please use the contact details on the back cover.

What Integra options are available for Gas?

Traditional Chimneys

For rooms with a traditional chimney (known as a class 1 flue) there is a deep **Convector Engine** (pages 4 & 19) with an amazing heat output of 4kW and an efficiency approaching 60%. This Engine is open fronted and available with a choice of manual or remote control and is also available in LPG.

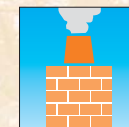

If you can bare to sacrifice an open fire for our new glass fronted **High Efficiency (HE) Engine** (pages 3 & 11) you can achieve 4kW with an increased efficiency of over 80%.

Pre-fabricated or Pre-cast Flues

For rooms with a flue but no traditional chimney breast there is a Classic Multiflue Engine (pages 7 & 18) with a heat output of 3.3kW and an efficiency approaching 50%. These flues often consist of a pre-cast fluepipe built inside the cavity of a wall and can often be seen from outside by a metal cowl or raised ridge tile on a roof instead of a traditional chimney pot.

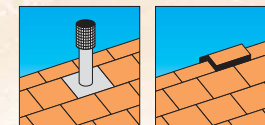

No Chimney Options

For rooms with no chimney or flue but a suitable external wall there is an open fronted fan-assisted **Powerflue Engine** (page 20) with a heat output of 3.3kW and an efficiency approaching 50%.

If you can sacrifice the open gas fire for our new glass fronted **Balanced Flue Engine** (page 16) you can achieve a quieter operation with an output of 4.3kW and an increased efficiency approaching 94%.

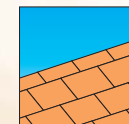

What Integra options are available for Solid Fuel?

There is a **Solid Fuel Integra Suite** available in many of the Integra designs suitable for wood burning and smokeless fuels - see Page 13.

What Integra options are available for Electric?

There is an **Electric Integra Suite** available in many of the Integra designs - see Page 12.

Are the Mantels shown in the brochure available?

Yes, all mantels shown in the brochure are available from your Retailer (and are interchangeable). Standard mantel dimensions are shown on page 22 (but smaller sizes are often available).

Material options include Turkish Limestone, Italian Marble, Chinese Black Granite and timber such as Solid Oak and Pine.



Anson Black HE

Cast	Anson Integra Black
Mantel	Chelsea Mocha Beige
Hearth	Granite 1448mm x 432mm (57" x 17")
Gas Fire	HE (High Efficiency) shown
Solid Fuel	Yes – see page 13
Electric	Yes – see page 12

Anson Integra

Full Polish

The Anson Integra Full Polish has a contemporary feel about it with its stunning fully polished finish providing a splendid contrast to that of the Athena mantel shown here in black granite.



Cast	Anson Integra Full Polish
Mantel	Athena Black Granite
Hearth	Granite 1448mm x 432mm (57" x 17")
Gas Fire	Convector shown
Solid Fuel	Yes – see page 13
Electric	Yes – see page 12



Ashbourne Integra

Polished

The Ashbourne Integra is a traditional decorative arched insert with the intricate detail shown in a highlight polish finish. An equally splendid but more discreet look is achieved using a matt black finish.

The Ashbourne is shown inside the Verona marble mantel in Italian Carrara (also available in black granite or Crema Marfil beige marble).



Cast	Ashbourne Integra Polished
Mantel	Verona Carrara Marble
Hearth	Granite 1448mm x 432mm (57" x 17")
Gas Fire	Convector shown
Solid Fuel	Yes – see page 13
Electric	Yes – see page 12

Oxford Integra

Polished

The Oxford Integra is a typical art nouveau period casting shown here in a highly polished finish (also available in matt black).

The tulip design on the canopy compliments the Liberty tile set displayed in ivory and burgundy.

The Oxford is shown inside the Limerick cast-iron mantel in a highlight polished finish sitting on a black granite hearth.



Cast	Oxford Integra Polished
Mantel	Limerick Cast Iron
Tiles	Liberty (Ivory/Burgundy)
Hearth	Granite 1448mm x 432mm (57" x 17")
Gas Fire	Convector shown

Washington Integra

Polished

The Washington Integra is a simple square design as opposed to the usual arched design. The casting is shown in a polished finish and is also available in matt black.

The York mantel is suitable for smaller chimney breasts and is shown here in beige Crema Marfil pure marble sitting on a black granite hearth.



Cast	Washington Integra Polished
Mantel	York Crema Marfil
Hearth	Granite 1372mm x 381mm (54" x 15")
Gas Fire	Classic Multiflue shown

Anson Integra

Matt Black

The Anson Integra is a simple arched insert shown here in an understated matt black finish.

The simplicity of the casting compliments the bold corbels of the Traditions solid oak Richmond mantel in a period finish (Antiqued pine also available).



Cast	Anson Integra Black
Mantel	Richmond Solid Oak
Hearth	Granite 1372mm x 381mm (54" x 15")
Gas Fire	Convactor shown
Solid Fuel	Yes – see page 13
Electric	Yes – see page 12

Jesmond Integra

Full Polish

The Jesmond Integra is shown in full polish with a set of Art Deco sleeves giving a very contemporary look. A more subtle look can be obtained in matt black and the sleeves can be replaced by tiles to add some colour.

The mantel shown is the Mayfair in Mocha Beige marble and is also available in Crema Marfil, Carrara, Limestone and Black Granite.



This Integra is also available with a decorative floral canopy and becomes the Roma Integra.

Cast	Jesmond Integra Full Polish
Mantel	Mayfair Mocha Beige
Sleeves	Art Deco Full Polish
Hearth	Granite 1448mm x 432mm (57" x 17")
Gas Fire	Convector shown



Anson Integra

Half Polish

The Anson Integra Half Polish is an elegant arched insert with a matt black outer band contrasting with a highly polished interior.

The casting looks quite exquisite with the rather grand Durham mantel in beige Crema Marfil pure marble. The base is a simple black granite hearth.



Cast	Anson Integra Half Polish
Mantel	Durham Crema Marfil
Hearth	Granite 1448mm x 432mm (57" x 17")
Gas Fire	Convector shown
Solid Fuel	Yes – see page 13
Electric	Yes – see page 12

Majestic Integra

Polished

The Majestic Integra is a plain matt black insert with a simple polished arched band giving a more discreet and minimalist feel.

This casting is shown inside the Flat Victorian Mantel in Turkish Limestone (but also available in Black Granite or Carrara Pure Marble).



The glass fronted HE (High Efficiency) Engine boasts an impressive output of 4kW with an efficiency of over 80%.

Cast	Majestic Integra Polished
Mantel	Flat Victorian Limestone
Hearth	Granite 1372mm x 381mm (54" x 15")
Gas Fire	HE (High Efficiency) shown
Solid Fuel	Yes – see page 13
Electric	Yes – see page 12



Electric Integra

Anson Full Polish

The Anson Electric Integra is shown in full polish with a chrome electro-plated finish giving a beautiful contemporary look. Also available in other arched designs the suite is complete with a remote control 2kW fan assisted heater (fan is behind canopy) with a realistic flame effect. The mantel shown is the Durham in stunning Black Granite.



Realistic flame effect

EASY TO FIT

The Electric Integra is a flat wall fixing which allows it to be fitted to any wall without the need to break into the plaster or brickwork (using a standard 76mm (3") rebated mantel).

Cast	Anson Electric Integra Full Polish
Mantel	Durham Black Granite
Hearth	Granite 1448mm x 432mm (57" x 17")
Electric	Electric Inset shown



Solid Fuel Integra

Majestic

The Solid Fuel (SF) Integra is shown in the Majestic design but is also available in the Anson and Ashbourne designs and finishes.

The mantel shown is the Edwardian Corbel in Turkish Limestone.

Suitable for wood burning and smokeless fuels the SF Integra Inset below, boasts an output up to 5kW and an efficiency approaching 70%.

An Airwash system helps to keep the window clean allowing you to enjoy the flame pattern in full. The door simply clips open and closed with an operating tool.



A hollow in the Integra Outer Fascia canopy (see Assembly p22) allows access to connect a flue liner to the spigot or flue outlet (for maximum efficiency and safety).

Cast	Majestic SF Integra
Mantel	Edwardian Corbel Limestone
*Hearth	Granite 1448mm x 457mm (57" x 18")
Solid Fuel	SF Inset as shown

**NOTE: Hearths fitted for solid fuel may have specific requirements to allow for expansion. Seek appropriate advice.*



Glen Integra

Matt Black

The Glen Integra is a traditional Victorian design. Shown in matt black the Glen is also available in an antique or highlight polished finish.

The handpainted tubeline tiles depict a burgundy coloured tulip (other colours and designs are available on p17).

The sturdy Kielder mantel displays several beautiful mouldings and is shown here in solid oak (also available in solid pine).



Cast	Glen Integra Black
Mantel	Kielder Solid Oak
Tiles	Tulip (Ivory/Burgundy)
Hearth	Granite 1372mm x 381mm (54" x 15")
Gas Fire	Convector shown

Aston Integra

Antique

The Aston Integra is another traditional design looking very elegant in an antique finish very similar to the old fashioned black lead but these days graphite is used.

The Aston is also available in a matt black or highlight polished finish.

The handpainted tubeline tiles depict a blue iris flower (other colours and designs are available on p17).

The mantel shown is the Balmoral in solid pine (with an antique finish) and this mantel is also available in solid oak.

Cast	Aston Integra Antique
Mantel	Balmoral Solid Pine
Tiles	Oriental Iris (Ivory/Blue)
Hearth	Granite 1372mm x 381mm (54" x 15")
Gas Fire	Convector shown



Eden Integra

Matt Black

The Eden Integra may look very traditional in a matt black finish furnished with beautiful Oriental Iris tiles in ivory & burgundy.

This fireplace, however, in common with all the other Integra castings in this brochure can be fitted into a room with no chimney or flue.

The **Integra Balanced Flue** gas fire (shown in the picture), boasts an output of 4.3kW and an extraordinary efficiency of 94%.

Those living in a new or converted property should no longer need to sacrifice their choice of a traditional cast-iron fireplace due to inefficiency or the lack of a chimney.

The Eden is shown with the Sherwood solid oak mantel which is also available in solid pine.

Cast	Eden Integra Black
Mantel	Sherwood Solid Oak
Tiles	Oriental Iris (Ivory/Burgundy)
Hearth	Granite 1372mm x 381mm (54" x 15")
Gas Fire	Balanced Flue shown



Hand Painted Tubeline Tiles & Cast-Iron Sleeves

Tubeline Tiles were traditionally made to withstand the high temperatures generated by a working fireplace and performed the practical function of reflecting heat into the room when placed at an angle facing inward. With a choice of five designs and various colour options, two runs of five tiles make up a set to fit

into an Integra casting. The Luscia and Mediterranean Poppy tile sets include a left and right handed design. Our tubeline tiles are individually handpainted in the traditional way and will be subject to colour variation and normal crazing.

Cast-iron Sleeves are an alternative to the more colourful tubeline tiles. Sleeves are supplied in pairs to suit an Integra casting and these are available in a matt black, antique or highlight polished finish. The Art Deco Sleeve design, as shown on page 9, is also available in Full Polish.

Liberty



Brown Yellow Ivory Blue Green Burgundy Honey Yellow Ivory Burgundy

Oriental Iris

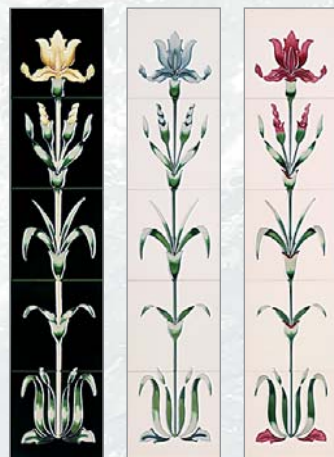

Green Yellow Ivory Blue Ivory Burgundy

Luscia



Honey Yellow Ivory Blue Ivory Burgundy

Mediterranean Poppy



Honey Yellow Ivory Burgundy Green Burgundy Ivory Blue

Tulip

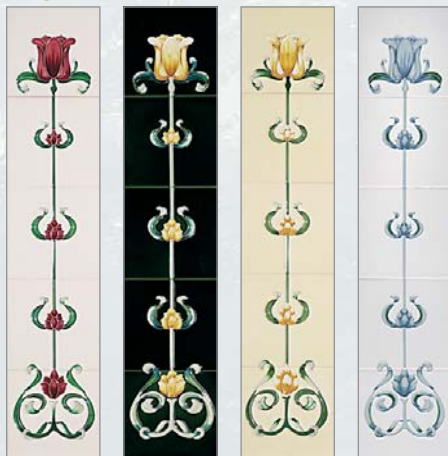

Ivory Burgundy Green Yellow Honey Yellow Ivory Blue

Cast-iron Sleeves



Lily Urn Med Poppy Tulip

Cast Iron Care

Packaging

Your Integra cast-iron fireplace is packaged so as to minimise exposure to adverse elements and should reach you in perfect condition. The product should be stored in a warm, dry environment and remain packaged until the fireplace is ready to be installed. This will prevent accidental damage being caused, which will not be covered under warranty. It is essential that you inspect your Integra casting prior to installation as it will be deemed to be of merchantable quality thereafter and no liability will be accepted for product removal, reinstallation or redecoration.

Cleaning

Your Integra casting requires only the minimum upkeep and it should remain in superb condition for many years. Matt black, antique or polished finishes can be maintained simply by dusting with a dedicated dry paint brush.

Warning

Cast-iron products are vulnerable to rust and tarnishing if exposed to dampness or water. Avoid the use of damp cloths, water-based liquids, furniture polish, detergents, oils, grease etc. onto the surface of the cast-iron. Should your fireplace become wet for any reason, dab it gently with a simple dry cloth. This should prevent any tarnishing or rust from forming. It is normal for some discoloration to occur to the working parts of a cast-iron fireplace.

Important Information

Products shown in this brochure are manufactured for Cast Tec Ltd., who, with a professional group of companies, distribute them exclusively in the U.K.

Goods must be checked prior to installation, as no responsibility will be accepted thereafter for the redecoration, removal or reinstallation of products.

Faulted goods must be reported within 48hours.

Installation should be carried out by a professional Gas Safe or HETAS Registered fireplace fitter. No responsibility will be accepted for damage or problems arising from an incorrect or unqualified installation.

Integra is a registered trademark and the Integra Split Fascia Concept is patented by Agnews who are the manufacturers of the cast iron products shown in the brochure.

Integra Engines are CE approved and manufactured specifically to suit the Integra Casting.

No responsibility will be accepted for problems arising where a gas or electric appliance has been used which is not approved or suitable to fit into the Integra Casting or where the fitting has taken place without the relevant instructions.

Cast Tec Ltd., reserve the right to delay or withdraw products, change designs, specifications or materials without prior notice due to continuous product development or supply problems.

Photographs and designs shown in this brochure are the copyright and design rights of Cast Tec Ltd. and can only be used or copied with permission.

Gas Fires with Trims & Frets

Multiflue

The Classic Multiflue is a simple yet effective coal effect fire being designed to fit almost any chimney or flue-type. Its cosy flame picture and 3.3kW output make it a welcome edition to any living room.

Shown here with a chrome trim and Media fret in black & chrome, the Classic Multiflue is also available in a brass or black finish with a choice of fret.

The Traditions solid oak Grizedale mantel in a period finish looks elegant against the contrast of the black granite hearth set and chrome embellishments of the gas fire.

Mantel	Grizedale Oak
Back panel	Granite 940mm x 940mm (37" x 37")
Hearth	Granite 1372mm x 381mm (54" x 15")
Trim	Chrome
Fret	Media - Black & Chrome
Gas Fire	Classic Multiflue



Gas Fires with Trims & Frets

Convector

The Integra Convector stands alone in the convector market with its impressive 4kW output delivering the warmth and efficiency you would expect.

Suitable for traditional chimneys with its extra depth the Integra Convector has an impressive flame picture and is available in either a manual or hand held remote control.

Shown here with a black trim and Bauhaus fret in black, the Integra Convector is also available with a brass or chrome trim and a choice of fret.

The Traditions solid oak Rothbury mantel in a period finish gives a rather minimalist and understated look when combined with the highly polished cast-iron of the Hilton fascia shown here in a Half Polish finish.

The Hilton fascia is also available in a Full Polish, Matt Black or Polished moulding only version.

Cast	Hilton Half Polish
Mantel	Rothbury Oak
Hearth	Granite 1372mm x 381mm (54" x 15")
Trim	Black
Fret	Bauhaus - Black
Gas Fire	Integra Convector (NG & LPG option)



Gas Fires with Trims & Frets

Powerflue

The Integra Powerflue has been designed specifically for homes without a chimney or flue.

A fan operated flue system allows the 3.3kW output gas fire with its realistic flame picture to be fitted to a suitable external wall.

Shown here with a brass trim and brass New Wave fret, the Integra Powerflue is also available with a chrome or black trim and a choice of fret.

The Traditions solid oak Corinth mantel in a period finish has a splendid curved inner moulding complimenting the unusual curve of the black granite hearth.

A new **Integra Balanced Flue** gas fire shown on page 16 boasts a higher output and efficiency than the Powerflue due to its glass fronted design.

Mantel	Corinth Solid Oak
Back panel	Granite 37" x 37"
Hearth	Granite Half Moon 1372mm x 381mm (54" x 15")
Trim	Brass
Fret	New Wave - Brass
Gas Fire	Integra Powerflue



Gas Fires with Trims & Frets

High Efficiency

The HE (High Efficiency) is an attractive gas fire which, similar to the convector, benefits from a substantial 4kW output, but unlike the convector, the HE is glass fronted, and this difference increases the efficiency from 60% to over 80% and in effect gives you more heat for less cost.

Shown here with a black trim and Bauhaus fret in black, the Integra HE is also available with a brass or chrome trim and a choice of fret.

The HE is shown inside a fully polished Hilton fascia casting which contrasts pleasantly with the dense black granite of the Flat Victorian mantel.

The Hilton fascia is also available in Half Polish (p19), Matt Black or with the Moulding Polished only and the Flat Victorian mantel is also available in Italian Carrara marble or Turkish Limestone.

Cast	Hilton Full Polish
Mantel	Flat Victorian Black Granite
Hearth	Granite 1372mm x 381mm (54" x 15")
Trim	Black
Fret	Bauhaus - Black
Gas Fire	Integra HE (High Efficiency)





Cast Assembly Details

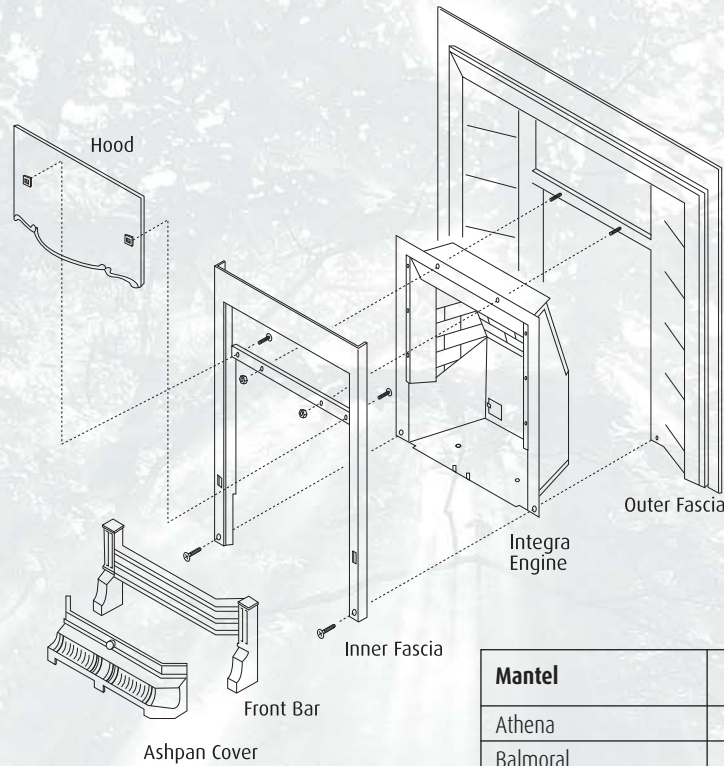

Easy to fit

The Integra casting can be comfortably housed inside a standard 76mm (3") rebated mantel which alleviates the need for a fitter to knock into the plasterwork or brickwork of a wall.

In addition, the gas fire engine can be serviced or even replaced simply by removing the inner fascia.

Cast & Mantel Dimensions

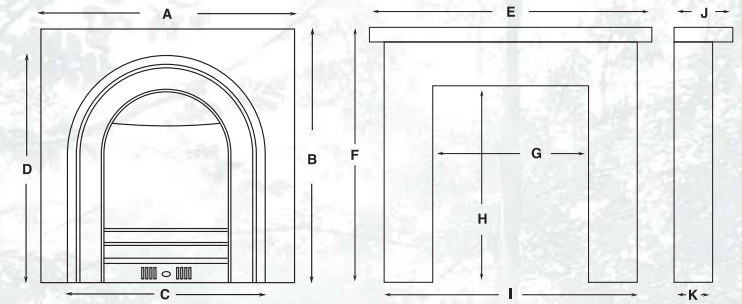

A: width. **B:** height. **C&D:** minimum fire surround aperture required.

Integra Castings	A (width)	B (height)	C	D
Anson, Ashbourne & Majestic	960	960	825	880
Aston, Eden & Glen	970	960	890	880
Hilton	955	955	865	820
Jesmond, Roma & Washington	970	960	890	880
Oxford	970	960	880	870

Mantel	E Shelf Length	F Height	G Int Width	H Int Height	I Base	J Shelf Width	K Rebate
Athena	1525	1150	965/815	915	Variable	250	76
Balmoral	1375	1135	915	915	1240	215	25/76
Chelsea	1520	1225	915	915	Variable	235	76
Corinth	1370	1130	915	920	1230	210	25/76
Danbury	1372	1225	915	915	1200	200	25/76
Durham	1520	1140	940/790	915	Variable	300	76
Edwardian Corbel	1455	1140	915	915	Variable	255	76
Flat Victorian	1470	1150	965/865	915	Variable	205	76
Grizedale	1370	1135	900	900	1215	195	25/76
Kielder	1365	1220	915	915	1225	230	25/76
Limerick	1530	1200	915	915	1400	220	76
Mayfair	1467	1205	915	915	Variable	190	76
Richmond	1475	1145	915	915	1330	240	25/76
Rothbury	1370	1135	915	915	1230	210	25/76
Verona	1510	1150	940/790	915	Variable	250	76
York	1370	1140	860/970	915	Variable	195	76

Frets & Trims



Bauhaus

-  Black
-  Brass
-  Polished (as shown)





Media

-  Black & Chrome
-  Black & Brass (as shown)



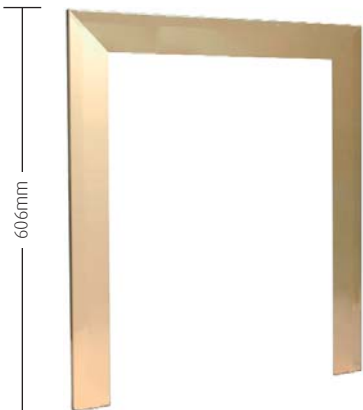

New Wave

-  Black (as shown)
-  Brass
-  Chrome



Trim

-  Black
-  Brass (as shown)
-  Chrome

606mm

513mm

Gas Fire Specifications

Classic Multiflue

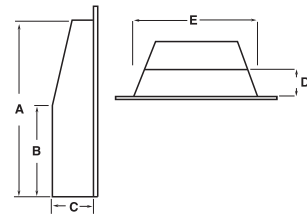

Dimensions	Input High	6.5kW
A 550mm	Output High	3.3kW
B 302mm	Efficiency	50%
C 120mm	Air vent required	No
D 70mm		
E 329mm		



High Efficiency

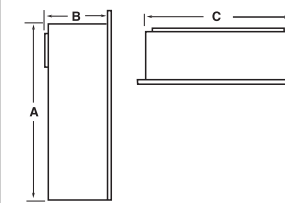

Dimensions	Input High	5.0kW
A 550mm	Output High	4.0kW
B 230mm	Efficiency	80%
C 400mm	Air vent required	No



Integra Convector

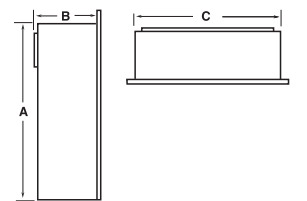

Dimensions	Input High	6.9kW
A 550mm	Output High	4.0kW
B 250mm	Efficiency	60%
C 400mm	Air vent required	No



Balanced Flue

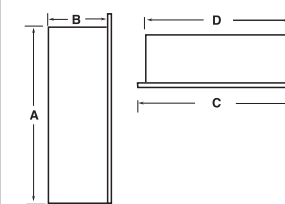

Dimensions	Input High	4.6kW
A 550mm	Output High	4.3kW
B 189mm	Efficiency	94%
C 497mm	Air vent required	No
D 406mm		

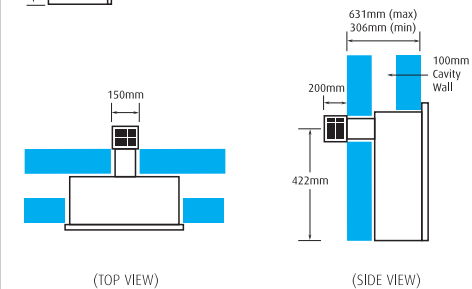

Integra Powerflue

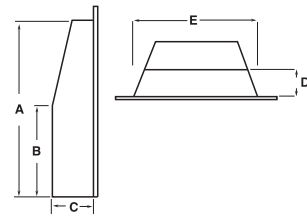

Dimensions	Input High	6.5kW
A 550mm	Output High	3.3kW
B 457mm	Efficiency	50%
C 105mm	Air vent required	No
D 90mm		
E 325mm		

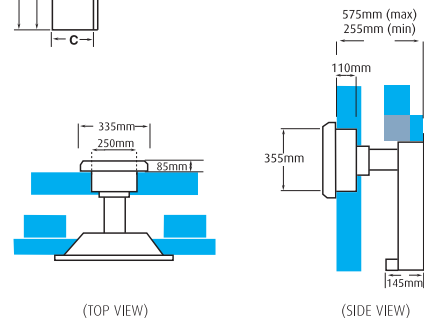

External Housing

Accessories

Matt black cast-iron paint, grate polish (for antique finishes) or metal polish (for polished finishes) can be applied to your cast-iron fireplace but only in exceptional circumstances with expert advice and taking the utmost care.





Thanks to Paul Agnew, Maggie & Alastair
Produced by Irving Design
Photography by Colin Thompson
V3 2009

CASTTEC

Cast Tec Ltd
East Side, Tyne Dock
South Shields NE33 5SP
Tel: 0191 497 4280
Fax: 0191 497 4288
Email: info@casttec.co.uk
Web: www.casttec.co.uk